

$$N = \int_{\mathcal{A}} \sigma_{zz} d\mathcal{A}$$

$$Q_y = \int_{\mathcal{A}} \tau_{yz} d\mathcal{A}$$

$$Q_x = \int_{\mathcal{A}} \tau_{zx} d\mathcal{A}$$

$$M_x \equiv M_{(G,x)} = \int_{\mathcal{A}} \sigma_z y d\mathcal{A}$$

$$M_y \equiv M_{(G,y)} = - \int_{\mathcal{A}} \sigma_z x d\mathcal{A}$$

$$M_t \equiv M_{(C,z)} = \int_{\mathcal{A}} [\tau_{yz}(x - x_C) - \tau_{zx}(y - y_C)] d\mathcal{A}$$

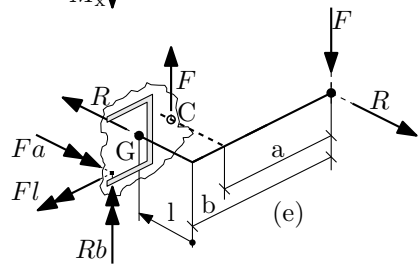
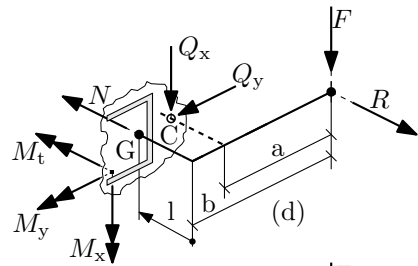
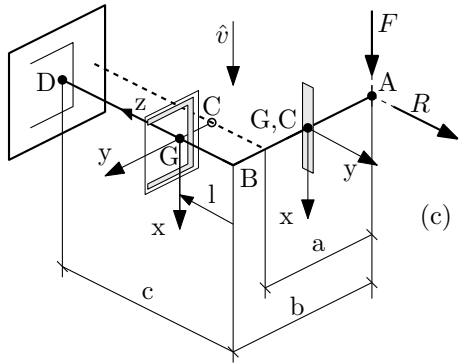
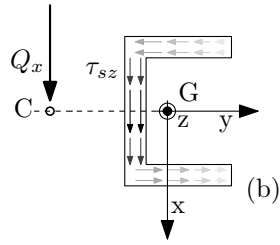
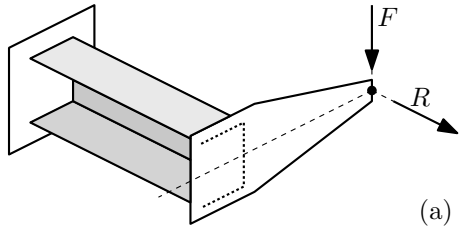

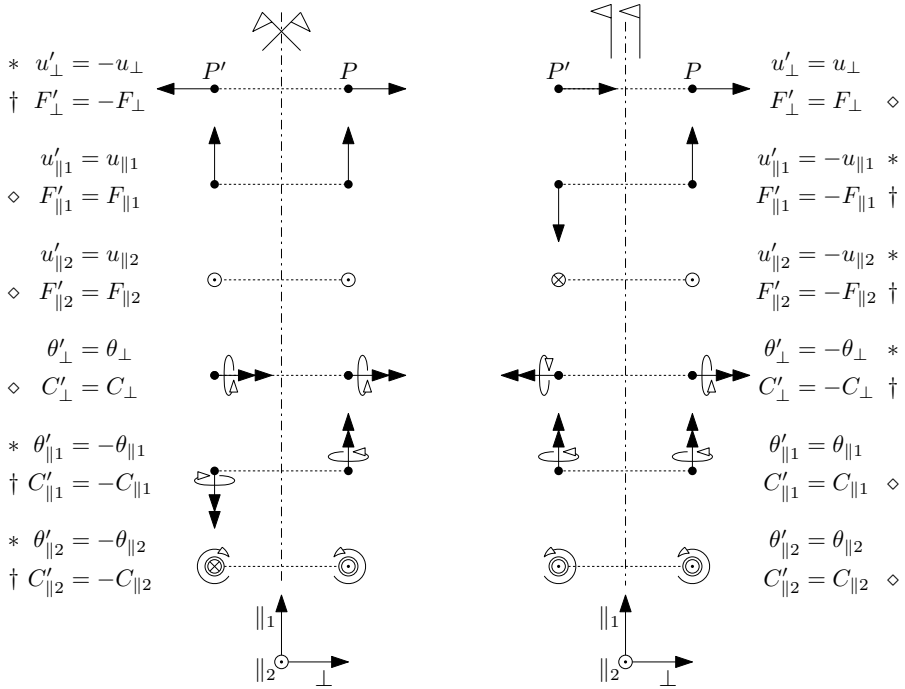
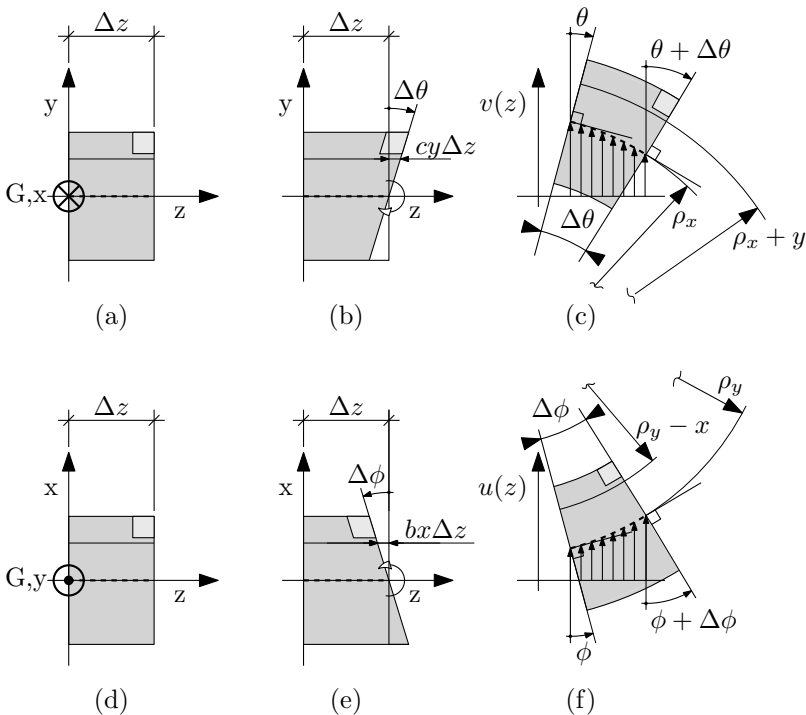

Figure 1: An overview of symmetrical and skew-symmetrical (generalized) loading and displacements.



$$\epsilon_z = a + bx + cy \quad (1)$$

$$\frac{d\theta}{dz} = \frac{1}{\rho_x}, \quad \theta = -\frac{dv}{dz}, \quad \frac{d^2v}{dz^2} = -\frac{1}{\rho_x} \quad (2)$$

$$\frac{d\phi}{dz} = \frac{1}{\rho_y}, \quad \phi = +\frac{du}{dz}, \quad \frac{d^2u}{dz^2} = +\frac{1}{\rho_y} \quad (3)$$

$$\sigma_z = E_z \epsilon_z; \quad \epsilon_z = e - \frac{1}{\rho_y}x + \frac{1}{\rho_x}y \quad (4)$$

$$N = \iint_{\mathcal{A}} E_z \epsilon_z dA = \overline{E} \overline{A} e \quad (5)$$

$$M_x = \iint_{\mathcal{A}} E_z \epsilon_z y dA = \overline{E} \overline{J}_{xx} \frac{1}{\rho_x} - \overline{E} \overline{J}_{xy} \frac{1}{\rho_y} \quad (6)$$

$$M_y = -\iint_{\mathcal{A}} E_z \epsilon_z x dA = -\overline{E} \overline{J}_{xy} \frac{1}{\rho_x} + \overline{E} \overline{J}_{yy} \frac{1}{\rho_y} \quad (7)$$

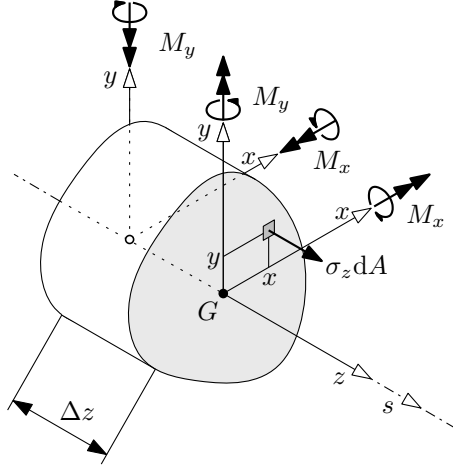

$$\overline{EA} = \iint_{\mathcal{A}} E_z(x, y) dA \quad (8)$$

$$\overline{EJ}_{xx} = \iint_{\mathcal{A}} E_z(x, y) yy dA \quad (9)$$

$$\overline{EJ}_{xy} = \iint_{\mathcal{A}} E_z(x, y) yx dA \quad (10)$$

$$\overline{EJ}_{yy} = \iint_{\mathcal{A}} E_z(x, y) xx dA \quad (11)$$

$$e = \frac{N}{\overline{EA}}. \quad (12)$$

$$\frac{1}{\rho_x} = \frac{M_x \overline{EJ}_{yy} + M_y \overline{EJ}_{xy}}{\overline{EJ}_{xx} \overline{EJ}_{yy} - \overline{EJ}_{xy}^2} \quad (13)$$

$$\frac{1}{\rho_y} = \frac{M_x \overline{EJ}_{xy} + M_y \overline{EJ}_{xx}}{\overline{EJ}_{xx} \overline{EJ}_{yy} - \overline{EJ}_{xy}^2} \quad (14)$$

$$\frac{1}{\rho_{\text{eq}}} = \sqrt{\frac{1}{\rho_x^2} + \frac{1}{\rho_y^2}} \quad (15)$$

$$\sigma_z = E_z \epsilon_z; \quad \epsilon_z = \alpha M_x + \beta M_y + \gamma N \quad (16)$$

$$\alpha(x, y, \overline{EJ}_{**}) = \frac{-\overline{EJ}_{xy}x + \overline{EJ}_{yy}y}{\overline{EJ}_{xx}\overline{EJ}_{yy} - \overline{EJ}_{xy}^2} \quad (17)$$

$$\beta(x, y, \overline{EJ}_{**}) = \frac{-\overline{EJ}_{xx}x + \overline{EJ}_{xy}y}{\overline{EJ}_{xx}\overline{EJ}_{yy} - \overline{EJ}_{xy}^2} \quad (18)$$

$$\gamma(\overline{EA}) = \frac{1}{\overline{EA}}. \quad (19)$$

$$(x_N, y_N) \equiv e\rho_{\text{eq}}^2 \left( \frac{1}{\rho_y}, -\frac{1}{\rho_x} \right);$$

$$\hat{n}_{\parallel} = \rho_{\text{eq}} \left( \frac{1}{\rho_x}, \frac{1}{\rho_y} \right),$$

$$\hat{n}_{\perp} = \rho_{\text{eq}} \left( -\frac{1}{\rho_y}, \frac{1}{\rho_x} \right),$$

$$\begin{bmatrix} M_x \\ M_y \end{bmatrix} = \zeta \hat{n}_{\parallel} = \lambda \begin{bmatrix} \frac{1}{\rho_x} \\ \frac{1}{\rho_y} \end{bmatrix} \quad (20)$$

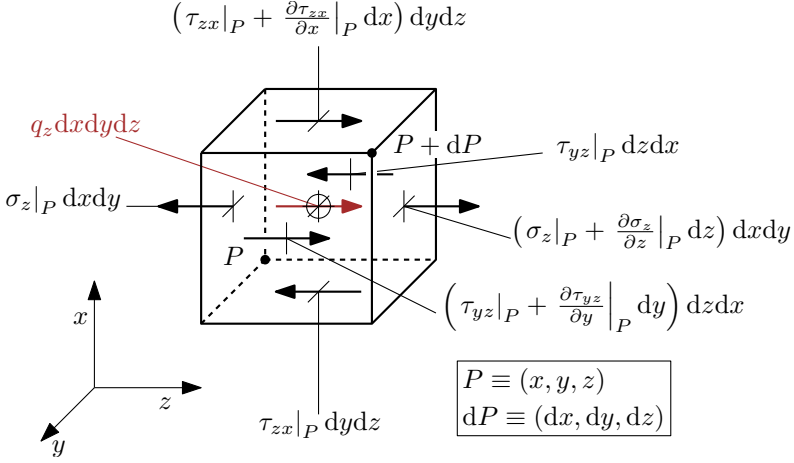

$$S_y = \frac{dM_x}{dz}, \quad S_x = -\frac{dM_y}{dz}, \quad (21)$$

$$\frac{d\sigma_z}{dz} = E_z \alpha(x, y, \overline{EJ}_{**}) S_y - E_z \beta(x, y, \overline{EJ}_{**}) S_x \quad (22)$$

$$\frac{d\tau_{zx}}{dx} + \frac{d\tau_{yz}}{dy} + \frac{d\sigma_z}{dz} + q_z = 0 \quad (23)$$

$$\bar{\tau}_{zi} t = \int_{A^*} \frac{d\sigma_z}{dz} dA, \quad (24)$$

$$\bar{\tau}_{zi} = \frac{1}{t} \int_t \tau_{zi} dr \quad (25)$$

$$\bar{\tau}_{zi} t = \int_{A^*} \left( \frac{y S_y}{J_{xx}} + \frac{x S_x}{J_{yy}} \right) dA = \frac{\bar{y}^* A^*}{J_{xx}} S_y + \frac{\bar{x}^* A^*}{J_{yy}} S_x, \quad (26)$$

$$\bar{\tau}_{zi} t = q_{zi} = \int_0^s \int_{-t/2}^{t/2} \frac{d\sigma_z}{dz} dr d\zeta \approx \int_0^s \frac{d\sigma_z}{dz} \Big|_{r=0} t d\zeta. \quad (27)$$

$$\bar{\tau}_{zi}(s)t(s) = q(s) = \int_a^s \frac{d\sigma_z}{dz} t d\zeta + \underbrace{\bar{\tau}_{zi}(a)t(a)}_{q_A}. \quad (28)$$

$$\tau(s) = \frac{S_1}{\mathcal{A}} f_{;S1}(s) + \frac{S_2}{\mathcal{A}} f_{;S2}(s) + \tau_A f_{;A}(s) + \tau_B f_{;B}(s) \quad (29)$$

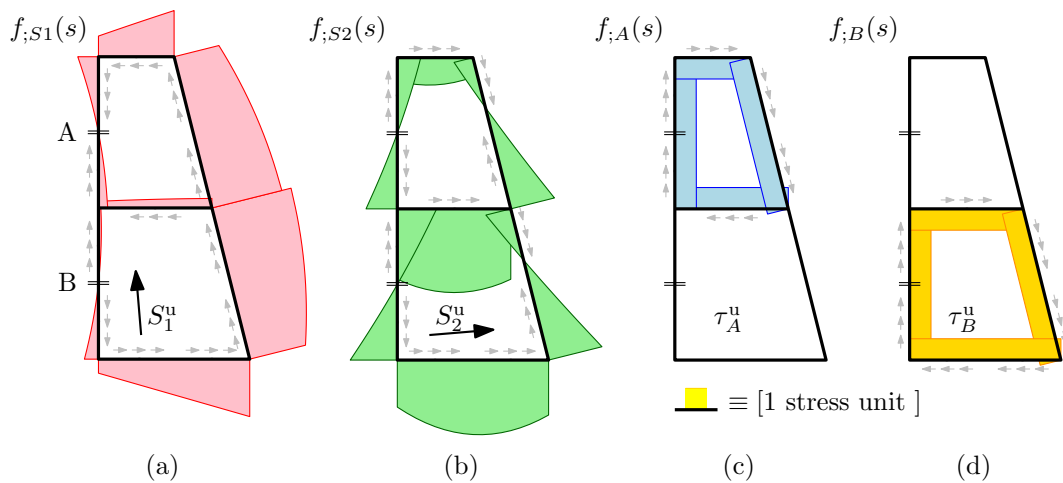
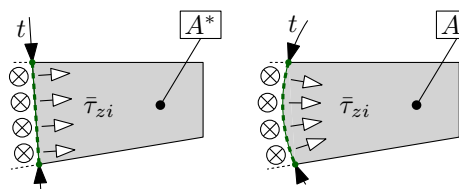
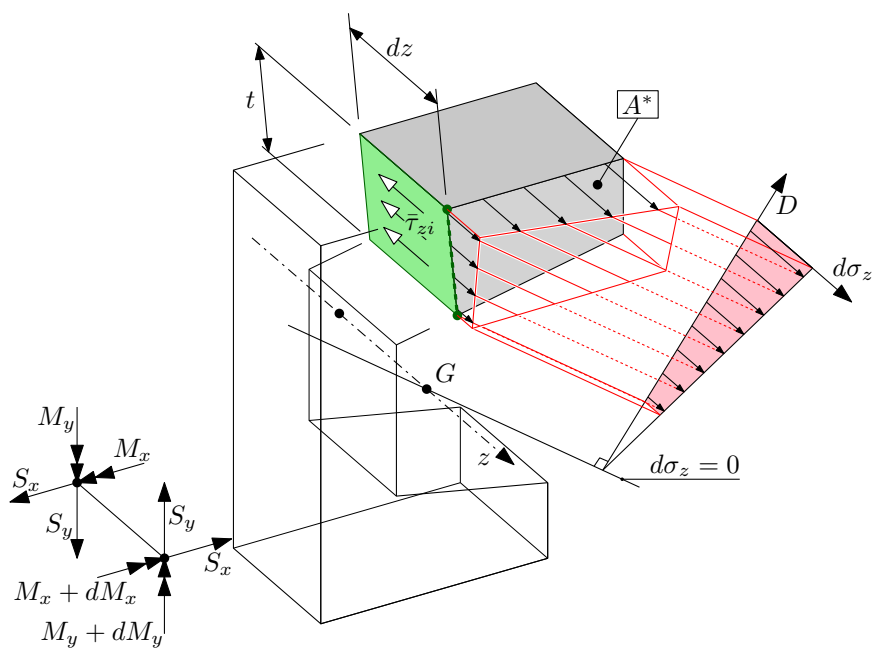



$$\Delta U = \int_s \frac{\tau^2}{2G_{sz}} t \Delta z ds \quad (30)$$

$$\frac{\partial \Delta U}{\partial \bar{\tau}_i} = \bar{\delta}_i t \Delta z \quad (31)$$

$$K_t = \frac{4A^2}{\oint \frac{1}{t} dl} \quad (32)$$

$$\tau_{\max} = \frac{M_t}{2t_{\min}A} \quad (33)$$

$$K_T \approx \frac{1}{3} \int_0^l t^3(s) ds \quad (34)$$

$$K_T \approx \frac{1}{3} \sum_i l_i t_i^3 \quad (35)$$

$$\tau_{\max} = \frac{M_t t_{\max}}{K_T} \quad (36)$$

$$q_i = \frac{\partial U}{\partial Q_i}$$

$$\frac{dU}{dl} = \frac{1}{2} \begin{pmatrix} N \\ M_x \\ M_y \\ Q_x \\ Q_y \\ M_t \end{pmatrix}^T \begin{pmatrix} a_{1,1} & g_{1,2} & g_{1,3} & i_{1,4} & i_{1,5} & i_{1,6} \\ 0 & b_{2,2} & e_{2,3} & i_{2,4} & i_{2,5} & i_{2,6} \\ 0 & 0 & b_{3,3} & i_{3,4} & i_{3,5} & i_{3,6} \\ 0 & 0 & 0 & c_{4,4} & f_{4,5} & h_{4,6} \\ 0 & 0 & 0 & 0 & c_{5,5} & h_{5,6} \\ 0 & 0 & 0 & 0 & 0 & d_{6,6} \end{pmatrix}_{\text{Sym}} \begin{pmatrix} N \\ M_x \\ M_y \\ Q_x \\ Q_y \\ M_t \end{pmatrix}, \quad (37)$$

$$a_{1,1} = \frac{1}{EA} \quad \{b_{2,2}, b_{3,3}, e_{2,3}\} = \frac{\{J_{yy}, J_{xx}, 2J_{xy}\}}{E(J_{xx}J_{yy} - J_{xy}^2)}$$

$$d_{6,6} = \frac{1}{GK_t} \quad \{c_{4,4}, c_{5,5}, f_{4,5}\} = \frac{\{\chi_x, \chi_y, \chi_{xy}\}}{GA}$$

$$\begin{aligned}
u_P &= u + z(1 + \check{\epsilon}_z) \frac{\cos \theta}{\sqrt{1 - \sin^2 \phi \sin^2 \theta}} \sin \phi \\
v_P &= v - z(1 + \check{\epsilon}_z) \frac{\cos \phi}{\sqrt{1 - \sin^2 \phi \sin^2 \theta}} \sin \theta \\
w_P &= w + z \left( (1 + \check{\epsilon}_z) \frac{\cos \phi \cos \theta}{\sqrt{1 - \sin^2 \phi \sin^2 \theta}} - 1 \right),
\end{aligned}$$

$$\begin{aligned}
\check{\epsilon}_z(z) &= \frac{1}{z} \int_0^z \epsilon_z d\zeta \\
&= \frac{1}{z} \int_0^z -\frac{\nu}{1 - \nu} (\epsilon_x + \epsilon_y) d\zeta,
\end{aligned}$$

$$u_P = u + z\phi \quad (38)$$

$$v_P = v - z\theta \quad (39)$$

$$w_P = w. \quad (40)$$

$$\frac{\partial w}{\partial x} = \bar{\gamma}_{zx} - \phi \quad (41)$$

$$\frac{\partial w}{\partial y} = \bar{\gamma}_{yz} + \theta \quad (42)$$

$$\epsilon_x = \frac{\partial u_P}{\partial x} = \frac{\partial u}{\partial x} + z \frac{\partial \phi}{\partial x} \quad (43)$$

$$\epsilon_y = \frac{\partial v_P}{\partial y} = \frac{\partial v}{\partial y} - z \frac{\partial \theta}{\partial y} \quad (44)$$

$$\gamma_{xy} = \frac{\partial u_P}{\partial y} + \frac{\partial v_P}{\partial x} \quad (45)$$

$$= \left( \frac{\partial u}{\partial y} + \frac{\partial v}{\partial x} \right) + z \left( \frac{\partial \phi}{\partial y} - \frac{\partial \theta}{\partial x} \right) \quad (46)$$

$$\underline{e} = \begin{bmatrix} \frac{\partial u}{\partial x} \\ \frac{\partial v}{\partial y} \\ \frac{\partial u}{\partial y} + \frac{\partial v}{\partial x} \end{bmatrix} = \begin{bmatrix} e_x \\ e_y \\ g_{xy} \end{bmatrix} \equiv \underline{e}_Q \quad (47)$$

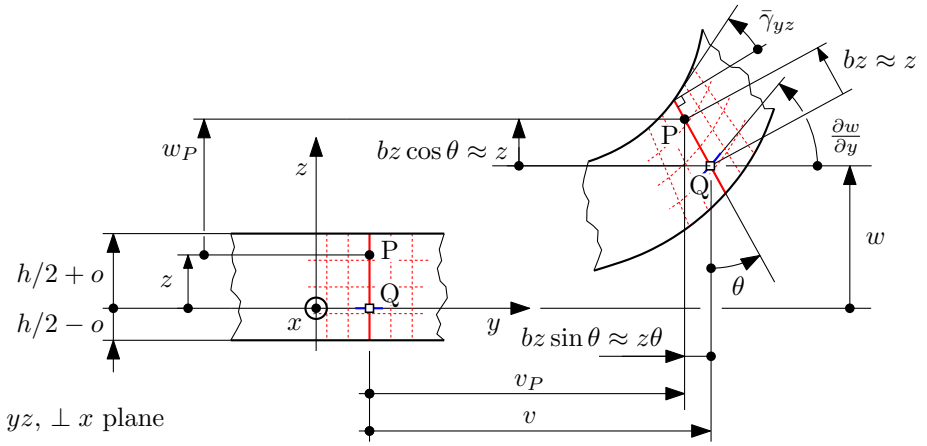
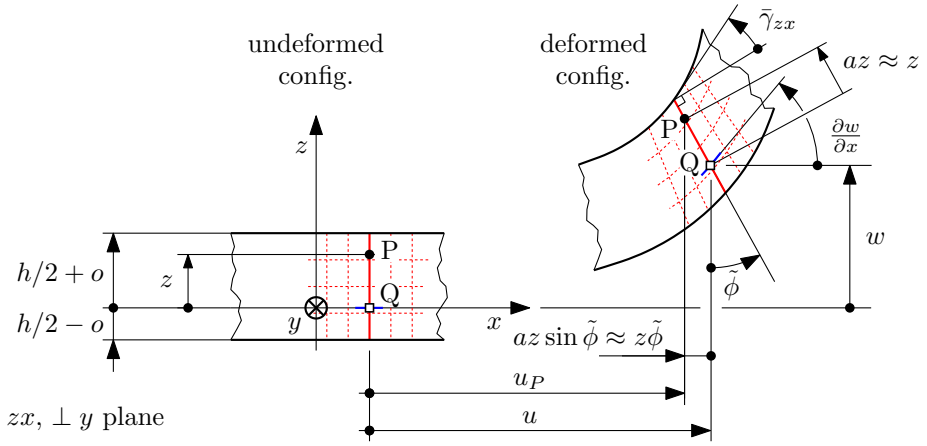

$$\{a, b\} = \frac{(1 + \tilde{\epsilon})}{\sqrt{1 - \sin^2 \phi \sin^2 \theta}} \{\cos \theta, \cos \phi\} \approx 1$$

$$\underline{\kappa} = \begin{bmatrix} +\frac{\partial\phi}{\partial x} \\ -\frac{\partial\theta}{\partial y} \\ +\frac{\partial\phi}{\partial y} - \frac{\partial\theta}{\partial x} \end{bmatrix} = \begin{bmatrix} \kappa_x \\ \kappa_y \\ \kappa_{xy} \end{bmatrix} \quad (48)$$

$$\underline{\epsilon}_P \equiv \underline{\epsilon} = \underline{e} + z \underline{\kappa}. \quad (49)$$

$$\begin{bmatrix} \sigma_x \\ \sigma_y \\ \tau_{xy} \end{bmatrix} = \underline{\sigma} = \underline{\underline{D}} \underline{\epsilon} = \underline{\underline{D}} \underline{e} + z \underline{\underline{D}} \underline{\kappa}, \quad (50)$$

$$\underline{\underline{D}} = \frac{E}{1-\nu^2} \begin{bmatrix} 1 & \nu & 0 \\ \nu & 1 & 0 \\ 0 & 0 & \frac{1-\nu}{2} \end{bmatrix}, \quad (51)$$

$$\epsilon_z = -\frac{\nu}{1-\nu} (\epsilon_x + \epsilon_y). \quad (52)$$

$$\begin{aligned} \underline{\underline{q}} &= \begin{bmatrix} q_x \\ q_y \\ q_{xy} \end{bmatrix} = \int_h \underline{\sigma} dz \\ &= \underbrace{\int_h \underline{\underline{D}} dz}_{\underline{\underline{a}}} \underline{e} + \underbrace{\int_h \underline{\underline{D}} z dz}_{\underline{\underline{b}}} \underline{\kappa} \end{aligned} \quad (53)$$

$$\underline{\underline{q}}_z = \begin{bmatrix} q_{xz} \\ q_{yz} \end{bmatrix} \quad q_{xz} = \int_h \tau_{zx} dz \quad q_{yz} = \int_h \tau_{yz} dz. \quad (54)$$

$$\begin{aligned} \underline{\underline{m}} &= \begin{bmatrix} m_x \\ m_y \\ m_{xy} \end{bmatrix} = \int_h \underline{\sigma} z dz \\ &= \underbrace{\int_h \underline{\underline{D}} z dz}_{\underline{\underline{b}} \equiv \underline{\underline{b}}^T} \underline{e} + \underbrace{\int_h \underline{\underline{D}} z^2 dz}_{\underline{\underline{c}}} \underline{\kappa}. \end{aligned} \quad (55)$$

$$\begin{bmatrix} \underline{\underline{q}} \\ \underline{\underline{m}} \end{bmatrix} = \begin{bmatrix} \underline{\underline{a}} & \underline{\underline{b}} \\ \underline{\underline{b}}^T & \underline{\underline{c}} \end{bmatrix} \begin{bmatrix} \underline{e} \\ \underline{\kappa} \end{bmatrix} \quad (56)$$

$$v^\dagger = \frac{1}{2} \begin{bmatrix} \underline{\mathbf{q}} \\ \underline{\mathbf{m}} \end{bmatrix}^\top \begin{bmatrix} \underline{\mathbf{e}} \\ \underline{\mathbf{\kappa}} \end{bmatrix} \quad (57)$$

$$= \frac{1}{2} \begin{bmatrix} \underline{\mathbf{e}} \\ \underline{\mathbf{\kappa}} \end{bmatrix}^\top \begin{bmatrix} \underline{\mathbf{a}} & \underline{\mathbf{b}} \\ \underline{\mathbf{b}}^\top & \underline{\mathbf{c}} \end{bmatrix} \begin{bmatrix} \underline{\mathbf{e}} \\ \underline{\mathbf{\kappa}} \end{bmatrix}. \quad (58)$$

$$\underline{\mathbf{a}} = h \underline{\mathbf{D}} \quad \underline{\mathbf{b}} = \underline{\mathbf{0}} \quad \underline{\mathbf{c}} = \frac{h^3}{12} \underline{\mathbf{D}},$$

$$\underline{\gamma}_z = \begin{bmatrix} \bar{\gamma}_{yz} \\ \bar{\gamma}_{zx} \end{bmatrix}$$

$$\underline{\mathbf{q}}_z = \begin{bmatrix} q_{xz} \\ q_{yz} \end{bmatrix}$$

$$v^\dagger = \frac{1}{2} \underline{\gamma}_z^\top \underline{\mathbf{q}}_z = \frac{1}{2} \bar{\gamma}_{xz} q_{xz} + \frac{1}{2} \bar{\gamma}_{yz} q_{yz}. \quad (59)$$

$$v^\dagger = \frac{1}{2} \underline{\gamma}_z^\top \underbrace{\left[ \chi \left( \frac{1}{h} \int_h \underline{\mathbf{G}}^{-1} dz \right)^{-1} h \right]}_{\underline{\Gamma}} \underline{\gamma}_z \quad (60)$$

$$\underline{\mathbf{G}} = \frac{E}{2(1+\nu)} \begin{bmatrix} 1 & 0 \\ 0 & 1 \end{bmatrix},$$

$$\underline{\mathbf{q}}_z = \underline{\Gamma} \underline{\gamma}_z. \quad (61)$$

$$\tau_{zx}(z) = - \int_{-\frac{h}{2}+o}^z \frac{\partial \sigma_x}{\partial x} + \frac{\partial \tau_{xy}}{\partial y} dz = \int_z^{+o+\frac{h}{2}} \frac{\partial \sigma_x}{\partial x} + \frac{\partial \tau_{xy}}{\partial y} dz \quad (62)$$

$$\tau_{yz}(z) = - \int_{-\frac{h}{2}+o}^z \frac{\partial \tau_{xy}}{\partial x} + \frac{\partial \sigma_y}{\partial y} dz = \int_z^{+o+\frac{h}{2}} \frac{\partial \tau_{xy}}{\partial x} + \frac{\partial \sigma_y}{\partial y} dz. \quad (63)$$

$$\underline{\mathbf{D}}_{123} = \begin{bmatrix} \frac{E_1}{1-\nu_{12}\nu_{21}} & \frac{\nu_{21}E_1}{1-\nu_{12}\nu_{21}} & 0 \\ \frac{\nu_{12}E_2}{1-\nu_{12}\nu_{21}} & \frac{E_2}{1-\nu_{12}\nu_{21}} & 0 \\ 0 & 0 & G_{12} \end{bmatrix} \quad (64)$$

$$\begin{bmatrix} \sigma_1 \\ \sigma_2 \\ \tau_{12} \end{bmatrix} = \underline{\mathbf{T}}_1 \begin{bmatrix} \sigma_x \\ \sigma_y \\ \tau_{xy} \end{bmatrix} \quad \begin{bmatrix} \epsilon_1 \\ \epsilon_2 \\ \gamma_{12} \end{bmatrix} = \underline{\mathbf{T}}_2 \begin{bmatrix} \epsilon_x \\ \epsilon_y \\ \gamma_{xy} \end{bmatrix} \quad (65)$$

$$\underline{\underline{\mathbf{T}}}_1 = \begin{bmatrix} m^2 & n^2 & 2mn \\ n^2 & m^2 & -2mn \\ -mn & mn & m^2 - n^2 \end{bmatrix} \quad (66)$$

$$\underline{\underline{\mathbf{T}}}_2 = \begin{bmatrix} m^2 & n^2 & mn \\ n^2 & m^2 & -mn \\ -2mn & 2mn & m^2 - n^2 \end{bmatrix} \quad (67)$$

$$m = \cos(\alpha) \quad n = \sin(\alpha) \quad (68)$$

$$\underline{\underline{\mathbf{T}}}_1^{-1}(+\alpha) = \underline{\underline{\mathbf{T}}}_1(-\alpha) \quad \underline{\underline{\mathbf{T}}}_2^{-1}(+\alpha) = \underline{\underline{\mathbf{T}}}_2(-\alpha) \quad (69)$$

$$\underline{\underline{\sigma}} = \underline{\underline{\mathbf{D}}} \underline{\underline{\epsilon}} \quad \underline{\underline{\mathbf{D}}} \equiv \underline{\underline{\mathbf{D}}}_{xyz} = \underline{\underline{\mathbf{T}}}_1^{-1} \underline{\underline{\mathbf{D}}}_{123} \underline{\underline{\mathbf{T}}}_2 \quad (70)$$

$$\underline{\underline{\mathbf{G}}} = \begin{bmatrix} n^2 G_{z1} + m^2 G_{2z} & mn G_{z1} - mn G_{2z} \\ mn G_{z1} - mn G_{2z} & m^2 G_{z1} + n^2 G_{2z} \end{bmatrix}.$$

$$k_x^* = \frac{12Fl}{Ebh^3} \quad (71)$$

$$m_x = m_x^* \quad m_y = 0 \quad \kappa_x = k_x^* \quad \kappa_y = -\nu k_x^*,$$

$$m_x = m_x^* \quad m_y = \nu m_x^* \quad \kappa_x = (1 - \nu^2) k_x^* \quad \kappa_y = 0.$$

$$g(y) \geq 0 \quad (72)$$

$$f(y) \geq 0 \quad (73)$$

$$g(y) \cdot f(y) = 0, \quad (74)$$



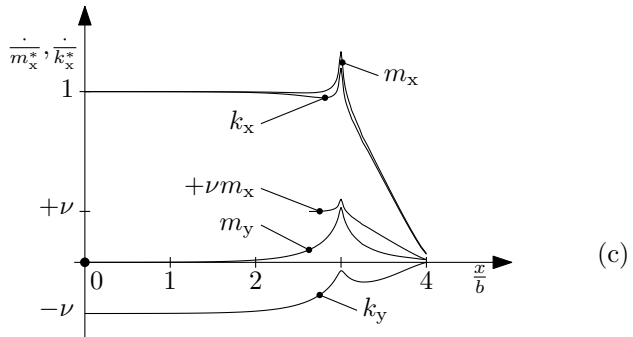
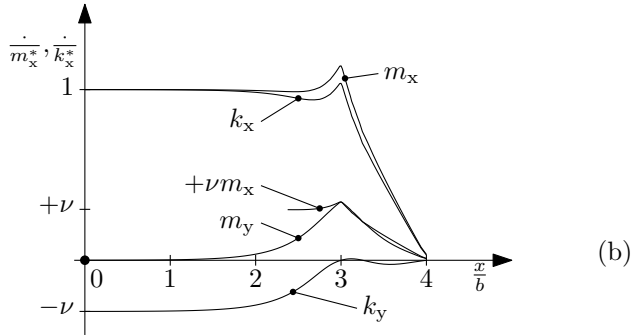
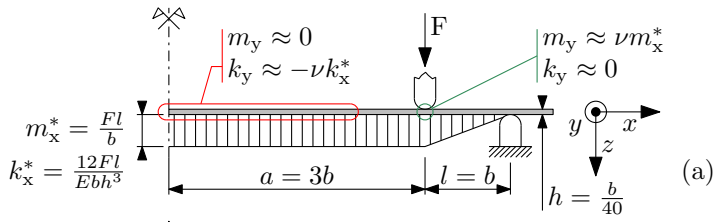

$$f(\xi, \eta) \stackrel{\text{def}}{=} \sum_i N_i(\xi, \eta) f_i \quad (75)$$

$$N_i(\xi, \eta) \stackrel{\text{def}}{=} \frac{1}{4} (1 \pm \xi) (1 \pm \eta), \quad (76)$$

$$\frac{\partial f}{\partial \xi} = \underbrace{\left( \frac{f_2 - f_1}{2} \right)}_{[\Delta f / \Delta \xi]_{12}} \underbrace{\left( \frac{1 - \eta}{2} \right)}_{N_1 + N_2} + \underbrace{\left( \frac{f_3 - f_4}{2} \right)}_{[\Delta f / \Delta \xi]_{43}} \underbrace{\left( \frac{1 + \eta}{2} \right)}_{N_4 + N_3} = a\eta + b \quad (77)$$

$$\frac{\partial f}{\partial \eta} = \left( \frac{f_4 - f_1}{2} \right) \left( \frac{1 - \xi}{2} \right) + \left( \frac{f_3 - f_2}{2} \right) \left( \frac{1 + \xi}{2} \right) = c\xi + d. \quad (78)$$

$$f(\xi, \eta) = \begin{bmatrix} N_1(\xi, \eta) & \cdots & N_i(\xi, \eta) & \cdots & N_n(\xi, \eta) \end{bmatrix} \begin{bmatrix} f_1 \\ \vdots \\ f_i \\ \vdots \\ f_n \end{bmatrix} \\ = \underline{\underline{\mathbf{N}}}(\xi, \eta) \underline{\underline{\mathbf{f}}}, \quad (79)$$

$$\underline{\underline{\mathbf{x}}}(\underline{\underline{\xi}}) = \underline{\underline{\mathbf{m}}}(\underline{\underline{\xi}}) = \sum_{i=1}^4 N_i(\underline{\underline{\xi}}) \underline{\underline{\mathbf{x}}}_i, \quad (80)$$

$$\underline{\underline{\mathbf{m}}}(\underline{\underline{\xi}}) = \begin{bmatrix} x(\xi, \eta) \\ y(\xi, \eta) \end{bmatrix}$$

$$x(\xi, \eta) = \sum_{i=1}^4 N_i(\xi, \eta) x_i \quad y(\xi, \eta) = \sum_{i=1}^4 N_i(\xi, \eta) y_i.$$

$$f(\xi, \eta) \stackrel{\text{def}}{=} \sum_i N_i(\xi, \eta) f_i \quad (81)$$

$$\begin{bmatrix} \frac{\partial f}{\partial \xi} \\ \frac{\partial f}{\partial \eta} \end{bmatrix} = \underbrace{\begin{bmatrix} \frac{\partial x}{\partial \xi} & \frac{\partial y}{\partial \xi} \\ \frac{\partial x}{\partial \eta} & \frac{\partial y}{\partial \eta} \end{bmatrix}}_{\underline{\underline{\mathbf{J}}}^\top(\xi, \eta; \underline{\underline{\mathbf{x}}}_i)} \begin{bmatrix} \frac{\partial f}{\partial x} \\ \frac{\partial f}{\partial y} \end{bmatrix} \quad (82)$$

$$\begin{bmatrix} \frac{\partial f}{\partial \xi} \\ \frac{\partial f}{\partial \eta} \end{bmatrix} = \sum_i \begin{bmatrix} \frac{\partial N_i}{\partial \xi} \\ \frac{\partial N_i}{\partial \eta} \end{bmatrix} f_i. \quad (83)$$

$$\underline{\mathbf{J}}^\top(\xi, \eta) = \begin{bmatrix} \frac{\partial x}{\partial \xi} & \frac{\partial y}{\partial \xi} \\ \frac{\partial x}{\partial \eta} & \frac{\partial y}{\partial \eta} \end{bmatrix} \quad (84)$$

$$= \sum_i \left( \begin{bmatrix} \frac{\partial N_i}{\partial \xi} & 0 \\ \frac{\partial N_i}{\partial \eta} & 0 \end{bmatrix} x_i + \begin{bmatrix} 0 & \frac{\partial N_i}{\partial \xi} \\ 0 & \frac{\partial N_i}{\partial \eta} \end{bmatrix} y_i \right) \quad (85)$$

$$\begin{bmatrix} \frac{\partial f}{\partial x} \\ \frac{\partial f}{\partial y} \end{bmatrix} = (\underline{\mathbf{J}}^\top)^{-1} \begin{bmatrix} \cdots & \frac{\partial N_i}{\partial \xi} & \cdots \\ \cdots & \frac{\partial N_i}{\partial \eta} & \cdots \end{bmatrix} \begin{bmatrix} \vdots \\ f_i \\ \vdots \end{bmatrix} \quad (86)$$

$$= \underbrace{(\underline{\mathbf{J}}^\top)^{-1} \begin{bmatrix} \frac{\partial N}{\partial \xi} \\ \frac{\partial N}{\partial \eta} \end{bmatrix}}_{\underline{\mathbf{L}}(\xi, \eta; \underline{x}_i), \text{ or just } \underline{\mathbf{L}}(\xi, \eta)} \underline{\mathbf{f}} \quad (87)$$

$$\int_{-1}^1 f(\xi) d\xi \approx \sum_{i=1}^n f(\xi_i) w_i; \quad (88)$$

$$p(\xi) \stackrel{\text{def}}{=} a_m \xi^m + a_{m-1} \xi^{m-1} + \dots + a_1 \xi + a_0$$

$$\int_{-1}^1 p(\xi) d\xi = \sum_{j=0}^m \frac{(-1)^j + 1}{j+1} a_j$$

$$r(a_j, (\xi_i, w_i)) \stackrel{\text{def}}{=} \sum_{i=1}^n p(\xi_i) w_i - \int_{-1}^1 p(\xi) d\xi \quad (89)$$

$$\left\{ \frac{\partial r(a_j, (\xi_i, w_i))}{\partial a_j} = 0, \quad j = 0 \dots m \right. \quad (90)$$

$$\int_a^b g(x) dx = \int_{-1}^1 g(m(\xi)) \frac{dm}{d\xi} d\xi \approx \sum_{i=1}^n g(m(\xi_i)) \frac{dm}{d\xi} \Big|_{\xi=\xi_i} w_i. \quad (91)$$

$$m(x) = \underbrace{\left( \frac{1-\xi}{2} \right)}_{N_1} a + \underbrace{\left( \frac{1+\xi}{2} \right)}_{N_2} b.$$

$$\frac{dm}{d\xi} = \frac{dN_1}{d\xi}a + \frac{dN_2}{d\xi}b = \frac{b-a}{2}$$

$$\int_a^b g(x)dx \approx \frac{b-a}{2} \sum_{i=1}^n g\left(\frac{b+a}{2} + \frac{b-a}{2}\xi_i\right) w_i. \quad (92)$$

$$\int_{-1}^1 \int_{-1}^1 f(\xi, \eta) d\xi d\eta \approx \sum_{i=1}^p \sum_{j=1}^q f(\xi_i, \eta_j) w_i w_j \quad (93)$$

$$\int_{-1}^1 \int_{-1}^1 f(\xi, \eta) d\xi d\eta \approx \sum_{l=1}^{pq} f(\underline{\xi}_l) w_l \quad (94)$$

$$\underline{\xi}_l = (\xi_i, \eta_j), \quad w_l = w_i w_j, \quad l = 1 \dots pq \quad (95)$$

$$dA_{xy} = \frac{1}{2!} \begin{vmatrix} 1 & x(\xi_P, \eta_P) & y(\xi_P, \eta_P) \\ 1 & x(\xi_P + d\xi, \eta_P) & y(\xi_P + d\xi, \eta_P) \\ 1 & x(\xi_P + d\xi, \eta_P + d\eta) & y(\xi_P + d\xi, \eta_P + d\eta) \end{vmatrix} + \frac{1}{2!} \begin{vmatrix} 1 & x(\xi_P + d\xi, \eta_P + d\eta) & y(\xi_P + d\xi, \eta_P + d\eta) \\ 1 & x(\xi_P, \eta_P + d\eta) & y(\xi_P, \eta_P + d\eta) \\ 1 & x(\xi_P, \eta_P) & y(\xi_P, \eta_P) \end{vmatrix}. \quad (96)$$

$$\mathcal{A} = \frac{1}{2!} \begin{vmatrix} 1 & x_1 & y_1 \\ 1 & x_2 & y_2 \\ 1 & x_3 & y_3 \end{vmatrix}, \quad \mathcal{H} = \frac{1}{n!} \begin{vmatrix} 1 & \underline{x}_1 \\ 1 & \underline{x}_2 \\ \vdots & \vdots \\ 1 & \underline{x}_{n+1} \end{vmatrix} \quad (97)$$

$$dA_{xy} \approx \frac{1}{2!} \begin{vmatrix} 1 & x & y \\ 1 & x + x_{,\xi}d\xi & y + y_{,\xi}d\xi \\ 1 & x + x_{,\xi}d\xi + x_{,\eta}d\eta & y + y_{,\xi}d\xi + y_{,\eta}d\eta \end{vmatrix} + \frac{1}{2!} \begin{vmatrix} 1 & x + x_{,\xi}d\xi + x_{,\eta}d\eta & y + y_{,\xi}d\xi + y_{,\eta}d\eta \\ 1 & x + x_{,\eta}d\eta & y + y_{,\eta}d\eta \\ 1 & x & y \end{vmatrix}$$

$$dA_{xy} = \frac{1}{2} \begin{vmatrix} 1 & x & y \\ 0 & x_{,\xi} & y_{,\xi} \\ 0 & x_{,\eta} & y_{,\eta} \end{vmatrix} d\xi d\eta + \frac{1}{2} \begin{vmatrix} 0 & x_{,\xi} & y_{,\xi} \\ 0 & x_{,\eta} & y_{,\eta} \\ 1 & x & y \end{vmatrix} d\xi d\eta$$

$$dA_{xy} = \frac{1}{2} \begin{vmatrix} x,\xi & y,\xi \\ x,\eta & y,\eta \end{vmatrix} d\xi d\eta + \frac{1}{2} \begin{vmatrix} x,\xi & y,\xi \\ x,\eta & y,\eta \end{vmatrix} d\xi d\eta$$

$$dA_{xy} = \underbrace{\begin{vmatrix} x,\xi & y,\xi \\ x,\eta & y,\eta \end{vmatrix}}_{|J^T(\xi_P, \eta_P; \underline{x}, \underline{y})|} dA_{\xi\eta} \quad (98)$$

$$\iint_{A_{xy}} g(x, y) dA_{xy} = \int_{-1}^1 \int_{-1}^1 g(x(\xi, \eta), y(\xi, \eta)) |J(\xi, \eta)| d\xi d\eta, \quad (99)$$

$$\iint_{A_{xy}} g(\underline{x}) dA_{xy} \approx \sum_{l=1}^{pq} g(\underline{x}(\underline{\xi}_l)) |J(\underline{\xi}_l)| w_l \quad (100)$$

$$dA_{xyz} = \sqrt{\begin{vmatrix} x,\xi & x,\eta \\ y,\xi & y,\eta \end{vmatrix}^2 + \begin{vmatrix} y,\xi & y,\eta \\ z,\xi & z,\eta \end{vmatrix}^2 + \begin{vmatrix} z,\xi & z,\eta \\ x,\xi & x,\eta \end{vmatrix}^2} d\xi d\eta \quad (101)$$

$$\underline{L}(\xi, \eta; \underline{x}_i) \approx \dots \quad (102)$$

This is a four-node, thick-shell element with global displacements and rotations as degrees of freedom. Bilinear interpolation is used for the coordinates, displacements and the rotations. The membrane strains are obtained from the displacement field; the curvatures from the rotation field. The transverse shear strains are calculated at the middle of the edges and interpolated to the integration points. In this way, a very efficient and simple element is obtained which exhibits correct behavior in the limiting case of thin shells. The element can be used in curved shell analysis as well as in the analysis of complicated plate structures. For the latter case, the element is easy to use since connections between intersecting plates can be modeled without tying. Due to its simple formulation when compared to the standard higher order shell elements, it is less expensive and, therefore, very attractive in nonlinear analysis. The element is not very sensitive to distortion, particularly if the corner nodes lie in the same plane. All constitutive relations can be used with this element.

— MSC.Marc 2013.1 Documentation, vol. B, Element library.

$$\begin{bmatrix} X(\xi, \eta) \\ Y(\xi, \eta) \\ Z(\xi, \eta) \end{bmatrix} = \sum_{i=1}^n N_i(\xi, \eta) \begin{bmatrix} X_i \\ Y_i \\ Z_i \end{bmatrix}, \quad \begin{bmatrix} x(\xi, \eta) \\ y(\xi, \eta) \\ z(\xi, \eta) \end{bmatrix} = \sum_{i=1}^n N_i(\xi, \eta) \begin{bmatrix} x_i \\ y_i \\ z_i \end{bmatrix} \quad (103)$$

$$\begin{bmatrix} u(\xi, \eta) \\ v(\xi, \eta) \\ w(\xi, \eta) \end{bmatrix} = \sum_{i=1}^4 N_i(\xi, \eta) \begin{bmatrix} u_i \\ v_i \\ w_i \end{bmatrix} \quad (104)$$

$$\begin{bmatrix} \theta(\xi, \eta) \\ \phi(\xi, \eta) \\ \psi(\xi, \eta) \end{bmatrix} = \sum_{i=1}^4 N_i(\xi, \eta) \begin{bmatrix} \theta_i \\ \phi_i \\ \psi_i \end{bmatrix} \quad (105)$$

$$\underline{\mathbf{u}} = \begin{bmatrix} \vdots \\ u_i \\ \vdots \end{bmatrix} \quad \underline{\mathbf{v}} = \begin{bmatrix} \vdots \\ v_i \\ \vdots \end{bmatrix} \quad \underline{\mathbf{w}} = \begin{bmatrix} \vdots \\ w_i \\ \vdots \end{bmatrix}$$

$$\underline{\boldsymbol{\theta}} = \begin{bmatrix} \vdots \\ \theta_i \\ \vdots \end{bmatrix} \quad \underline{\boldsymbol{\phi}} = \begin{bmatrix} \vdots \\ \phi_i \\ \vdots \end{bmatrix} \quad \underline{\boldsymbol{\psi}} = \begin{bmatrix} \vdots \\ \psi_i \\ \vdots \end{bmatrix}$$

$$u(\xi, \eta) = \underline{\mathbf{N}}(\xi, \eta) \underline{\mathbf{u}} \quad v(\xi, \eta) = \underline{\mathbf{N}}(\xi, \eta) \underline{\mathbf{v}}$$

$$\underline{\mathbf{d}}^\top = [\underline{\mathbf{u}}^\top \quad \underline{\mathbf{v}}^\top \quad \underline{\mathbf{w}}^\top \quad \underline{\boldsymbol{\theta}}^\top \quad \underline{\boldsymbol{\phi}}^\top \quad \underline{\boldsymbol{\psi}}^\top] \quad (106)$$

$$\begin{bmatrix} \frac{\partial u}{\partial x} \\ \frac{\partial u}{\partial y} \end{bmatrix} = \underbrace{(\underline{\mathbf{J}}')^{-1} \begin{bmatrix} \cdots & \frac{\partial N_i}{\partial \xi} & \cdots \\ \cdots & \frac{\partial N_i}{\partial \eta} & \cdots \end{bmatrix}}_{\underline{\mathbf{L}}(\xi, \eta; \mathbf{x}_i) \text{ or just } \underline{\mathbf{L}}(\xi, \eta)} \begin{bmatrix} \vdots \\ u_i \\ \vdots \end{bmatrix} \quad (107)$$

$$\begin{bmatrix} \frac{\partial u}{\partial x} \\ \frac{\partial u}{\partial y} \\ \frac{\partial v}{\partial x} \\ \frac{\partial v}{\partial y} \end{bmatrix} = \underbrace{\begin{bmatrix} \underline{\mathbf{L}}(\xi, \eta) & \underline{\mathbf{0}} \\ \underline{\mathbf{0}} & \underline{\mathbf{L}}(\xi, \eta) \end{bmatrix}}_{\underline{\mathbf{Q}}(\xi, \eta)} \begin{bmatrix} \underline{\mathbf{u}} \\ \underline{\mathbf{v}} \end{bmatrix} \quad (108)$$

$$\begin{bmatrix} \frac{\partial \theta}{\partial x} \\ \frac{\partial \theta}{\partial y} \\ \frac{\partial \phi}{\partial x} \\ \frac{\partial \phi}{\partial y} \end{bmatrix} = \underline{\mathbf{Q}}(\xi, \eta) \begin{bmatrix} \underline{\boldsymbol{\theta}} \\ \underline{\boldsymbol{\phi}} \end{bmatrix} \quad (109)$$

$$\begin{bmatrix} e_x \\ e_y \\ g_{xy} \end{bmatrix} = \underbrace{\begin{bmatrix} +1 & 0 & 0 & 0 \\ 0 & 0 & 0 & +1 \\ 0 & +1 & +1 & 0 \end{bmatrix}}_{\underline{\mathbf{H}}'} \begin{bmatrix} \frac{\partial u}{\partial x} \\ \frac{\partial u}{\partial y} \\ \frac{\partial v}{\partial x} \\ \frac{\partial v}{\partial y} \end{bmatrix} = \underline{\mathbf{H}}' \underline{\mathbf{Q}}(\xi, \eta) \begin{bmatrix} \underline{\mathbf{u}} \\ \underline{\mathbf{v}} \end{bmatrix} \quad (110)$$

$$\begin{bmatrix} \kappa_x \\ \kappa_y \\ \kappa_{xy} \end{bmatrix} = \underbrace{\begin{bmatrix} 0 & 0 & +1 & 0 \\ 0 & -1 & 0 & 0 \\ -1 & 0 & 0 & +1 \end{bmatrix}}_{\underline{\mathbf{H}}''} \begin{bmatrix} \frac{\partial \theta}{\partial x} \\ \frac{\partial \theta}{\partial y} \\ \frac{\partial \phi}{\partial x} \\ \frac{\partial \phi}{\partial y} \end{bmatrix} = \underline{\mathbf{H}}'' \underline{\mathbf{Q}}(\xi, \eta) \begin{bmatrix} \underline{\boldsymbol{\theta}} \\ \underline{\boldsymbol{\phi}} \end{bmatrix} \quad (111)$$

$$\underline{e} = \underbrace{\left[ \underline{\mathbf{H}}' \underline{\mathbf{Q}}(\xi, \eta) \quad \underline{\mathbf{0}} \quad \underline{\mathbf{0}} \quad \underline{\mathbf{0}} \quad \underline{\mathbf{0}} \right]}_{\underline{\mathbf{B}}_e(\xi, \eta)} \underline{\mathbf{d}} \quad (112)$$

$$\underline{\kappa} = \underbrace{\left[ \underline{\mathbf{0}} \quad \underline{\mathbf{0}} \quad \underline{\mathbf{0}} \quad \underline{\mathbf{H}}'' \underline{\mathbf{Q}}(\xi, \eta) \quad \underline{\mathbf{0}} \right]}_{\underline{\mathbf{B}}_\kappa(\xi, \eta)} \underline{\mathbf{d}}. \quad (113)$$

$$\underline{\epsilon}(\xi, \eta, z) = (\underline{\mathbf{B}}_e(\xi, \eta) + z \underline{\mathbf{B}}_\kappa(\xi, \eta)) \underline{\mathbf{d}}; \quad (114)$$

$$\begin{bmatrix} \bar{\gamma}_{zx} \\ \bar{\gamma}_{yz} \end{bmatrix} = \underline{\mathbf{L}}(\xi, \eta) \underline{\mathbf{w}} + \begin{bmatrix} \underline{\mathbf{0}} & + \underline{\mathbf{N}}(\xi, \eta) \\ - \underline{\mathbf{N}}(\xi, \eta) & \underline{\mathbf{0}} \end{bmatrix} \begin{bmatrix} \underline{\theta} \\ \underline{\phi} \end{bmatrix}, \quad (115)$$

$$\begin{bmatrix} \bar{\gamma}_{zx} \\ \bar{\gamma}_{yz} \end{bmatrix} = \underbrace{\left[ \underline{\mathbf{0}} \quad \underline{\mathbf{0}} \quad \underline{\mathbf{L}}(\xi, \eta) \quad \underline{\mathbf{0}} \quad \underline{\mathbf{N}}(\xi, \eta) \quad \underline{\mathbf{0}} \right]}_{\underline{\mathbf{B}}_\gamma(\xi, \eta)} \underline{\mathbf{d}} \quad (116)$$

$$\underline{\mathbf{d}}^\top = [\underline{\mathbf{u}}^\top \quad \underline{\mathbf{v}}^\top \quad \underline{\mathbf{w}}^\top \quad \underline{\theta}^\top \quad \underline{\phi}^\top \quad \underline{\psi}^\top] \quad (117)$$

$$\underline{\mathbf{G}}^\top = [\underline{\mathbf{U}}^\top \quad \underline{\mathbf{V}}^\top \quad \underline{\mathbf{W}}^\top \quad \underline{\Theta}^\top \quad \underline{\Phi}^\top \quad \underline{\Psi}^\top] \quad (118)$$

$$\delta \Upsilon_e = \delta \underline{\mathbf{d}}^\top \underline{\mathbf{G}}. \quad (119)$$

$$\underline{\sigma} = \underline{\mathbf{D}}(z) (\underline{\mathbf{B}}_e(\xi, \eta) + \underline{\mathbf{B}}_\kappa(\xi, \eta)z) \underline{\mathbf{d}} \quad (120)$$

$$\delta \underline{\epsilon} = (\underline{\mathbf{B}}_e(\xi, \eta) + \underline{\mathbf{B}}_\kappa(\xi, \eta)z) \delta \underline{\mathbf{d}} \quad (121)$$

$$\underline{\mathbf{q}} = (\underline{\mathbf{a}} \underline{\mathbf{B}}_e(\xi, \eta) + \underline{\mathbf{b}} \underline{\mathbf{B}}_\kappa(\xi, \eta)) \underline{\mathbf{d}} \quad (122)$$

$$\underline{\mathbf{m}} = (\underline{\mathbf{b}}^\top \underline{\mathbf{B}}_e(\xi, \eta) + \underline{\mathbf{c}} \underline{\mathbf{B}}_\kappa(\xi, \eta)) \underline{\mathbf{d}}, \quad (123)$$

$$\delta \underline{e} = \underline{\mathbf{B}}_e(\xi, \eta) \delta \underline{\mathbf{d}} \quad (124)$$

$$\delta \underline{\kappa} = \underline{\mathbf{B}}_\kappa(\xi, \eta) \delta \underline{\mathbf{d}}, \quad (125)$$

$$\begin{aligned} \delta \Upsilon_i^\dagger &= \iint_{\mathcal{A}} \int_h \delta \underline{\epsilon}^\top \underline{\sigma} dz d\mathcal{A} \\ &= \iint_{\mathcal{A}} \int_h ((\underline{\mathbf{B}}_e + \underline{\mathbf{B}}_\kappa z) \delta \underline{\mathbf{d}})^\top \underline{\mathbf{D}} (\underline{\mathbf{B}}_e + \underline{\mathbf{B}}_\kappa z) \underline{\mathbf{d}} dz d\mathcal{A} \\ &= \delta \underline{\mathbf{d}}^\top \left[ \iint_{\mathcal{A}} \int_h (\underline{\mathbf{B}}_e^\top + \underline{\mathbf{B}}_\kappa^\top z) \underline{\mathbf{D}} (\underline{\mathbf{B}}_e + \underline{\mathbf{B}}_\kappa z) dz d\mathcal{A} \right] \underline{\mathbf{d}} \\ &= \delta \underline{\mathbf{d}}^\top \underline{\mathbf{K}}^\dagger \underline{\mathbf{d}}, \end{aligned} \quad (126)$$



$$\begin{aligned}
\delta \Upsilon_i^\dagger &= \iint_{\mathcal{A}} (\delta \underline{e}^\top \underline{q} + \delta \underline{\kappa}^\top \underline{m}) d\mathcal{A} \\
&= \delta \underline{d}^\top \left[ \iint_{\mathcal{A}} \begin{bmatrix} \underline{\underline{B}}^e \\ \underline{\underline{B}}^\kappa \end{bmatrix}^\top \begin{bmatrix} \underline{a} & \underline{b} \\ \underline{b}^\top & \underline{c} \end{bmatrix} \begin{bmatrix} \underline{\underline{B}}^e \\ \underline{\underline{B}}^\kappa \end{bmatrix} d\mathcal{A} \right] \underline{d} \\
&= \delta \underline{d}^\top \underline{\underline{K}}_\sigma \underline{d}, \tag{127}
\end{aligned}$$

$$\{ \underline{a}, \underline{b}, \underline{c} \} = \int_h \underline{\underline{D}} \{1, z, z^2\} dz,$$

$$\begin{aligned}
\iiint_{\Omega} g(\xi, \eta, x, y, z) d\Omega &= \tag{128} \\
&= \int_{-1}^{+1} \int_{-1}^{+1} \int_{-\frac{h}{2}+o}^{+\frac{h}{2}+o} g(\xi, \eta, x(\xi, \eta), y(\xi, \eta), z) dz | \underline{\underline{J}}(\xi, \eta) | d\xi d\eta,
\end{aligned}$$

$$\begin{aligned}
\delta \Upsilon_i^\ddagger &= \iint_{\mathcal{A}} \delta \underline{\gamma}_z^\top \underline{q}_z d\mathcal{A} \\
&= \delta \underline{d}^\top \left[ \iint_{\mathcal{A}} \underline{\underline{B}}_\gamma^\top \underline{\underline{\Gamma}} \underline{\underline{B}}_\gamma d\mathcal{A} \right] \underline{d} \\
&= \delta \underline{d}^\top \underline{\underline{K}}^\ddagger \underline{d}. \tag{129}
\end{aligned}$$

$$\begin{aligned}
\delta \Upsilon_i &= \delta \Upsilon_i^\dagger + \delta \Upsilon_i^\ddagger \\
&= \delta \underline{d}^\top \left( \underline{\underline{K}}^\dagger + \underline{\underline{K}}^\ddagger \right) \underline{d} \\
&= \delta \underline{d}^\top \underline{\underline{K}} \underline{d}. \tag{130}
\end{aligned}$$

$$\delta \underline{d}^\top \underline{\underline{G}} = \delta \Upsilon_e = \delta \Upsilon_i = \delta \underline{d}^\top \underline{\underline{K}} \underline{d}, \quad \forall \delta \underline{d}, \tag{131}$$

$$\underline{\underline{G}} = \underline{\underline{K}} \underline{d}; \tag{132}$$

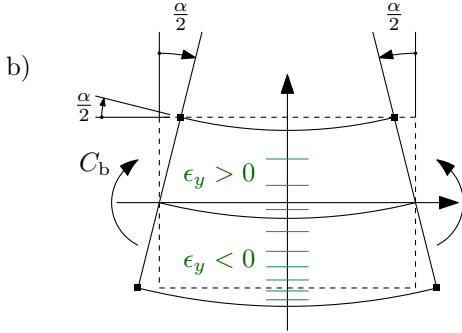
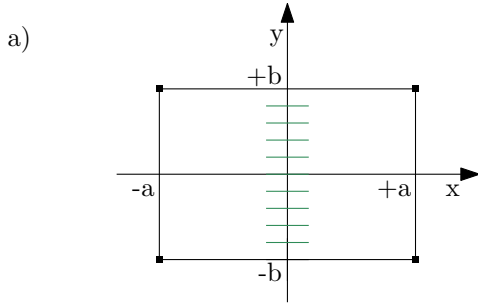

$$\begin{aligned}\epsilon_x &= -\frac{\alpha y}{2a} \\ \epsilon_y = \epsilon_z &= \nu \frac{\alpha y}{2a} \\ \gamma_{xy} &= 0 \\ u &= \frac{\alpha^2 E y^2}{8a^2}\end{aligned}$$

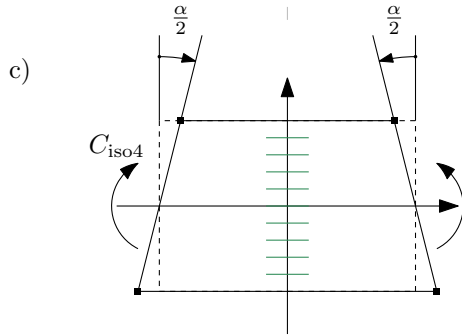

$$\begin{aligned}\epsilon_x &= -\frac{\alpha y}{2a} \\ \epsilon_y = 0, \epsilon_z &= \frac{\nu}{1-\nu} \frac{\alpha y}{2a} \\ \gamma_{xy} &= -\frac{\alpha x}{2a} \\ u &= \left(1 + \frac{\nu^2}{1-\nu^2}\right) \frac{E \alpha^2 y^2}{8a^2} + \frac{G \alpha^2 x^2}{8a^2}\end{aligned}$$

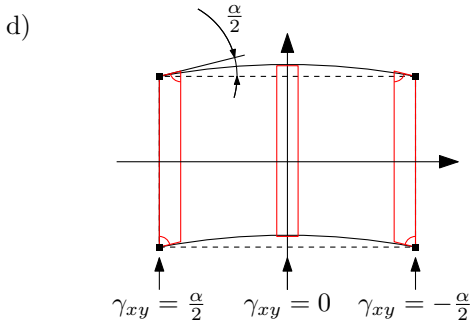

$$\begin{aligned}\frac{C_{iso4}}{C_b} &= \frac{1 + \frac{1-\nu}{2} \left(\frac{a}{b}\right)^2}{1-\nu^2} \\ &\approx 1.48 \text{ if } \nu = 0.3, \frac{a}{b} = 1\end{aligned}$$

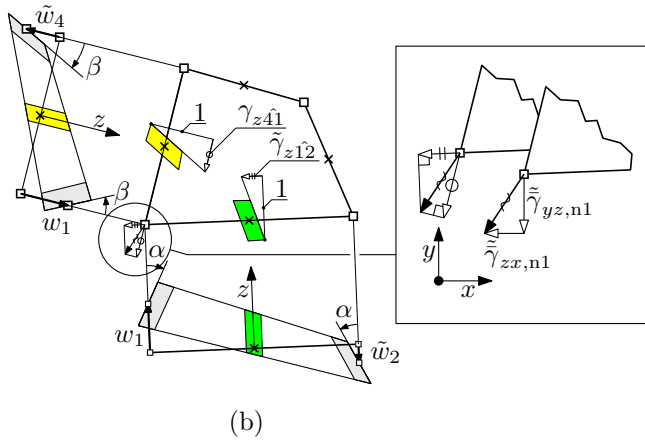
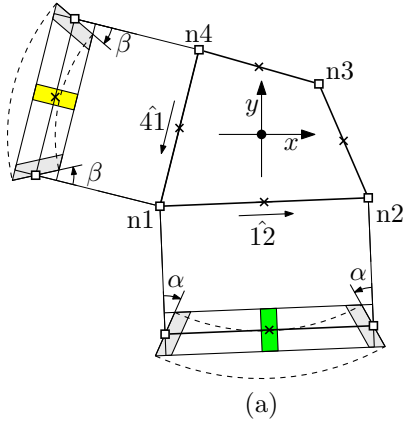

$$\underline{\underline{\mathbf{S}}}(\xi, \eta, z) = \begin{bmatrix} \dots & \hat{u}_i(\xi, \eta, z) & \dots \\ \dots & \hat{v}_i(\xi, \eta, z) & \dots \\ \dots & \hat{w}_i(\xi, \eta, z) & \dots \end{bmatrix} \quad (133)$$

$$\underline{\mathbf{u}}(\xi, \eta, z) = \underline{\underline{\mathbf{S}}}(\xi, \eta, z) \underline{\mathbf{d}}. \quad (134)$$

$$\underline{\dot{\mathbf{u}}}(\xi, \eta, z) = \underline{\underline{\mathbf{S}}}(\xi, \eta, z) \underline{\dot{\mathbf{d}}} \quad (135)$$

$$E_{\text{kin}} = \frac{1}{2} \iiint_{\Omega} \underline{\dot{\mathbf{u}}}^\top \underline{\dot{\mathbf{u}}} \rho d\Omega \quad (136)$$

$$E_{\text{kin}} = \frac{1}{2} \iiint_{\Omega} [\underline{\underline{\mathbf{S}}} \underline{\dot{\mathbf{d}}}]^\top [\underline{\underline{\mathbf{S}}} \underline{\dot{\mathbf{d}}}] \rho d\Omega, \quad (137)$$

$$E_{\text{kin}} = \frac{1}{2} \underline{\dot{\mathbf{d}}}^\top \left[ \iiint_{\Omega} \underline{\underline{\mathbf{S}}}^\top \underline{\underline{\mathbf{S}}} \rho d\Omega \right] \underline{\dot{\mathbf{d}}} = \frac{1}{2} \underline{\dot{\mathbf{d}}}^\top \underline{\underline{\mathbf{M}}} \underline{\dot{\mathbf{d}}}. \quad (138)$$

$$\underline{\underline{\mathbf{M}}} = \iiint_{\Omega} \underline{\underline{\mathbf{S}}}^\top \underline{\underline{\mathbf{S}}} \rho d\Omega, \quad (139)$$

$$\begin{aligned} \underline{\dot{\mathbf{d}}}^\top \underline{\mathbf{G}} &= \frac{dE_{\text{kin}}}{dt} = \frac{d}{dt} \left( \frac{1}{2} \underline{\dot{\mathbf{d}}}^\top \underline{\underline{\mathbf{M}}} \underline{\dot{\mathbf{d}}} \right) \\ &= \frac{1}{2} \left( \underline{\ddot{\mathbf{d}}}^\top \underline{\underline{\mathbf{M}}} \underline{\dot{\mathbf{d}}} + \underline{\dot{\mathbf{d}}}^\top \underline{\underline{\mathbf{M}}} \underline{\ddot{\mathbf{d}}} \right) \\ &= \underline{\dot{\mathbf{d}}}^\top \underline{\underline{\mathbf{M}}} \underline{\ddot{\mathbf{d}}}. \end{aligned}$$

$$\underline{\mathbf{G}} = \underline{\underline{\mathbf{M}}} \underline{\ddot{\mathbf{d}}} \quad (140)$$

$$\delta \underline{\mathbf{u}}(\xi, \eta, z) = \underline{\underline{\mathbf{S}}}(\xi, \eta, z) \delta \underline{\mathbf{d}}, \quad (141)$$

$$\begin{aligned} \delta \underline{\mathbf{d}}^\top \underline{\mathbf{F}} &= \iiint_{\Omega} (\delta \underline{\mathbf{u}})^\top \underline{\mathbf{p}} d\Omega \\ &= \iiint_{\Omega} (\underline{\underline{\mathbf{S}}} \delta \underline{\mathbf{d}})^\top \underline{\mathbf{p}} d\Omega \\ &= \delta \underline{\mathbf{d}}^\top \iiint_{\Omega} \underline{\underline{\mathbf{S}}}^\top \underline{\mathbf{p}} d\Omega, \end{aligned}$$

$$\underline{\mathbf{F}} = \iiint_{\Omega} \underline{\underline{\mathbf{S}}}^\top \underline{\mathbf{p}} d\Omega \quad (142)$$

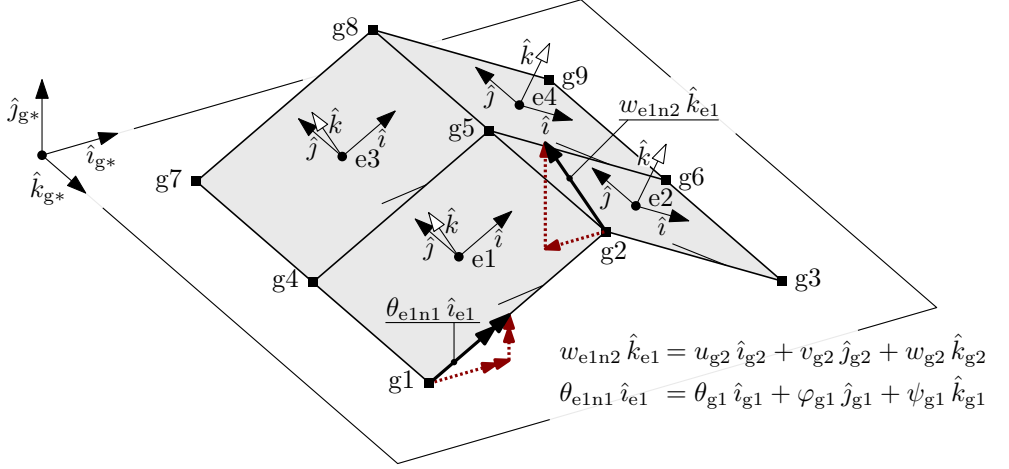

$$\underline{\mathbf{G}}_{ej} = \underline{\mathbf{K}}_{ej} \underline{\mathbf{d}}_{ej} \quad (143)$$

$$\underline{\mathbf{d}}_{gl} = \begin{bmatrix} u_{gl} \\ v_{gl} \\ w_{gl} \\ \theta_{gl} \\ \varphi_{gl} \\ \psi_{gl} \end{bmatrix}. \quad (144)$$

$$\underline{\mathbf{d}}_g^\top = [\underline{\mathbf{d}}_{g1}^\top \quad \underline{\mathbf{d}}_{g2}^\top \quad \dots \quad \underline{\mathbf{d}}_{gl}^\top \quad \dots \quad \underline{\mathbf{d}}_{gn}^\top] \quad (145)$$

$$\underline{\mathbf{F}}_g^\top = [\underline{\mathbf{F}}_{g1}^\top \quad \underline{\mathbf{F}}_{g2}^\top \quad \dots \quad \underline{\mathbf{F}}_{gl}^\top \quad \dots \quad \underline{\mathbf{F}}_{gn}^\top]; \quad (146)$$

$$\underline{\mathbf{R}}_g^\top = [\underline{\mathbf{R}}_{g1}^\top \quad \underline{\mathbf{R}}_{g2}^\top \quad \dots \quad \underline{\mathbf{R}}_{gl}^\top \quad \dots \quad \underline{\mathbf{R}}_{gn}^\top] \quad (147)$$

$$w_{e1n2} = \langle \hat{k}_{e1}, \hat{i}_{g2} \rangle u_{g2} + \langle \hat{k}_{e1}, \hat{j}_{g2} \rangle v_{g2} + \langle \hat{k}_{e1}, \hat{k}_{g2} \rangle w_{g2} \quad (148)$$

$$\theta_{e1n1} = \langle \hat{i}_{e1}, \hat{i}_{g1} \rangle \theta_{g1} + \langle \hat{i}_{e1}, \hat{j}_{g1} \rangle \varphi_{g1} + \langle \hat{i}_{e1}, \hat{k}_{g1} \rangle \psi_{g1} \quad (149)$$

$$\begin{aligned} [\underline{\mathbf{P}}_{e1}]_{10,7} &= \langle \hat{k}_{e1}, \hat{i}_{g2} \rangle & [\underline{\mathbf{P}}_{e1}]_{13,4} &= \langle \hat{i}_{e1}, \hat{i}_{g1} \rangle \\ [\underline{\mathbf{P}}_{e1}]_{10,8} &= \langle \hat{k}_{e1}, \hat{j}_{g2} \rangle & [\underline{\mathbf{P}}_{e1}]_{13,5} &= \langle \hat{i}_{e1}, \hat{j}_{g1} \rangle \\ [\underline{\mathbf{P}}_{e1}]_{10,9} &= \langle \hat{k}_{e1}, \hat{k}_{g2} \rangle & [\underline{\mathbf{P}}_{e1}]_{13,6} &= \langle \hat{i}_{e1}, \hat{k}_{g1} \rangle, \end{aligned}$$

| node | $X$   | $Y$   | $Z$  |
|------|-------|-------|------|
| g1   | $-ac$ | 0     | $+a$ |
| g2   | 0     | $+as$ | $+a$ |
| g3   | $+ac$ | 0     | $+a$ |
| g4   | $-ac$ | 0     | 0    |
| g5   | 0     | $+as$ | 0    |
| g6   | $+ac$ | 0     | 0    |
| g7   | $-ac$ | 0     | $-a$ |
| g8   | 0     | $+as$ | $-a$ |
| g9   | $+ac$ | 0     | $-a$ |

|               | $u_{ni}$ | $v_{ni}$ | $w_{ni}$ | $\theta_{ni}$ | $\varphi_{ni}$ | $\psi_{ni}$ |
|---------------|----------|----------|----------|---------------|----------------|-------------|
| $U_{ni}$      | █        | █        |          |               |                |             |
| $V_{ni}$      | █        | █        |          |               |                |             |
| $W_{ni}$      |          |          | █        | █             | █              |             |
| $\Theta_{ni}$ |          |          | █        | █             | █              |             |
| $\Phi_{ni}$   |          |          | █        | █             | █              |             |
| $\Psi_{ni}$   |          |          |          |               |                | █           |

$i = 1 \dots 4$

|    | n1 | n2 | n3 | n4 |
|----|----|----|----|----|
| e1 | g1 | g2 | g5 | g4 |
| e2 | g2 | g3 | g6 | g5 |
| e3 | g4 | g5 | g8 | g7 |
| e4 | g5 | g6 | g9 | g8 |

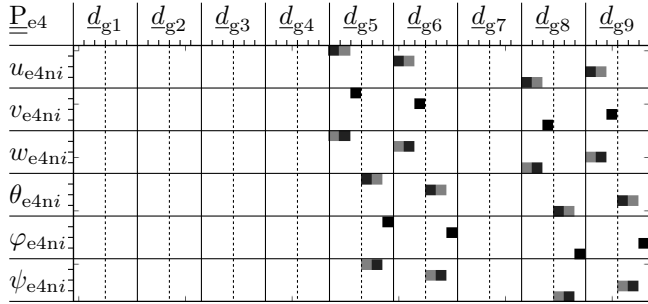
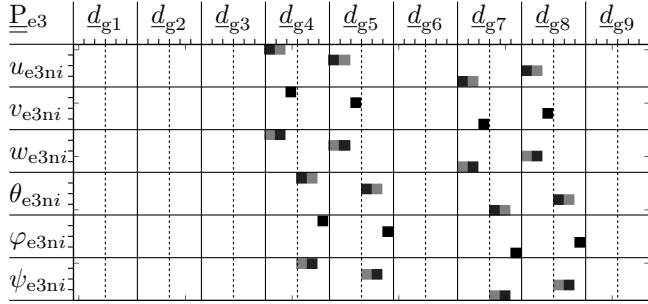
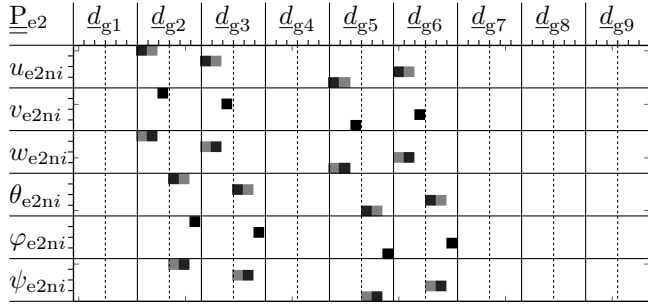
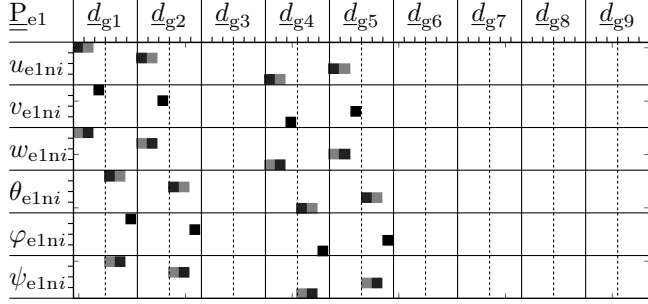

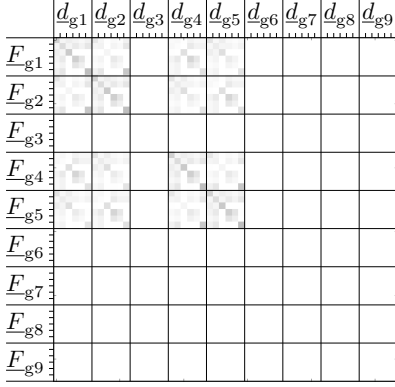

(a)

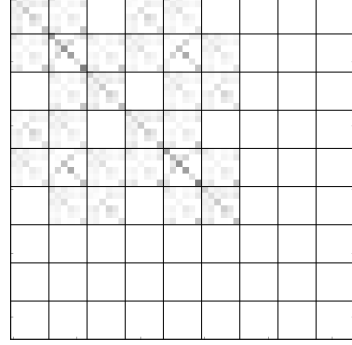

(b)

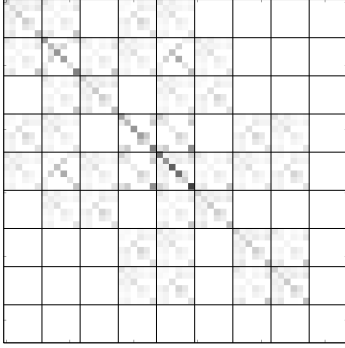

(c)

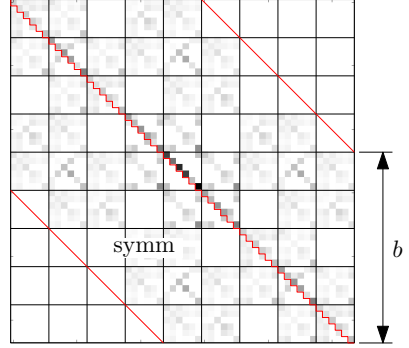

(d)

$$\underline{\mathbf{d}}_{ej} = \underline{\mathbf{P}}_{ej} \underline{\mathbf{d}}_g, \quad \forall j. \quad (150)$$

$$\underline{\mathbf{G}}_{ej} = \underline{\mathbf{K}}_{ej} \underline{\mathbf{P}}_{ej} \underline{\mathbf{d}}_g, \quad \forall j; \quad (151)$$

$$\delta \underline{\mathbf{d}}_g^\top \underline{\mathbf{G}}_{g \leftarrow ej} = (\underline{\mathbf{P}}_{ej} \delta \underline{\mathbf{d}}_g)^\top \underline{\mathbf{G}}_{ej}, \quad \forall \delta \underline{\mathbf{d}}_g \quad (152)$$

$$\underline{\mathbf{G}}_{g \leftarrow ej} = \underline{\mathbf{P}}_{ej}^\top \underline{\mathbf{G}}_{ej} \quad (153)$$

$$\underline{\mathbf{G}}_{g \leftarrow ej} = \underline{\mathbf{P}}_{ej}^\top \underline{\mathbf{K}}_{ej} \underline{\mathbf{P}}_{ej} \underline{\mathbf{d}}_g; \quad (154)$$

$$\underline{\mathbf{G}}_g = \sum_j \underline{\mathbf{G}}_{g \leftarrow ej} = \left( \sum_j \underbrace{\underline{\mathbf{P}}_{ej}^\top \underline{\mathbf{K}}_{ej} \underline{\mathbf{P}}_{ej}}_{\underline{\mathbf{K}}_{g \leftarrow ej}} \right) \underline{\mathbf{d}}_g = \underline{\mathbf{K}}_g \underline{\mathbf{d}}_g, \quad (155)$$



$$b_{e_j} = (i_{\max} - i_{\min} + 1)l, \quad (156)$$

$$b = \max_{e_j} b_{e_j} \quad (157)$$

$$\underline{\mathbf{F}}_g = \sum_j \underline{\mathbf{P}}_{e_j}^\top \underline{\mathbf{F}}_{e_j}; \quad (158)$$

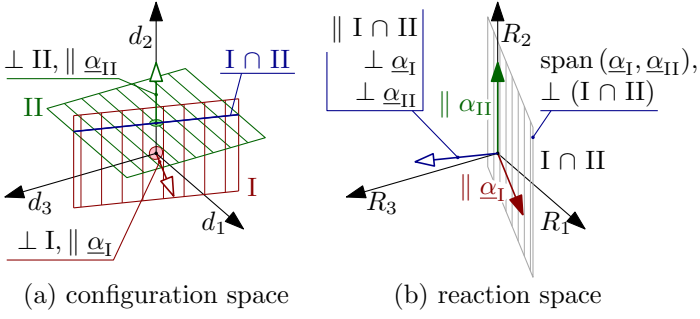
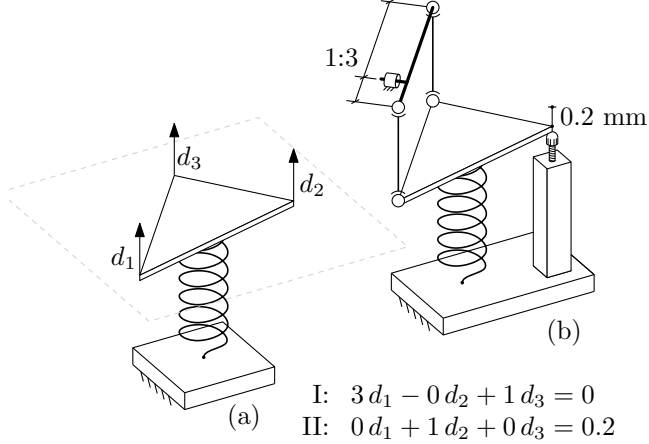

$$\sum_i \alpha_{ji} d_i = \underline{\alpha}_j^\top \underline{d} = \beta_j$$

$$\begin{aligned} \underline{\alpha}_I^\top &= [3 \quad 0 \quad 1] & \beta_I &= 0 \\ \underline{\alpha}_{II}^\top &= [0 \quad 1 \quad 0] & \beta_{II} &= 0.2 \end{aligned}$$

$$\sum_i \alpha_{ji} d_i = \underline{\alpha}_j^\top \underline{d} = \beta_j, \quad j = 1 \dots m \quad (159)$$

$$\underline{\mathcal{L}}^\top \underline{d} = \underline{\beta}. \quad (160)$$

$$\underline{\mathcal{L}}^\top \delta \underline{d} = \underline{0}, \quad (161)$$

$$\underline{R} = -\underline{\mathcal{L}} \underline{\ell}, \quad (162)$$

$$\underline{\mathbf{R}}^j = - \begin{bmatrix} \vdots \\ \alpha_{ji} \\ \vdots \end{bmatrix} \ell_j \quad (163)$$

$$\underline{\mathbf{K}} \underline{\mathbf{d}} = \underline{\mathbf{F}} + \underline{\mathbf{R}}. \quad (164)$$

$$\underline{\mathbf{K}} \underline{\mathbf{d}} + \underline{\mathcal{L}} \underline{\ell} = \underline{\mathbf{F}}$$

$$\begin{bmatrix} \underline{\mathbf{K}} & \underline{\mathcal{L}} \\ \underline{\mathcal{L}}^\top & \underline{\mathbf{0}} \end{bmatrix} \begin{bmatrix} \underline{\mathbf{d}} \\ \underline{\ell} \end{bmatrix} = \begin{bmatrix} \underline{\mathbf{F}} \\ \underline{\beta} \end{bmatrix}, \quad (165)$$

$$\frac{1}{2} \underline{\mathbf{d}}^\top \underline{\mathbf{K}} \underline{\mathbf{d}} - \underline{\mathbf{d}}^\top \underline{\mathbf{F}} + \underline{\ell}^\top (\underline{\mathcal{L}}^\top \underline{\mathbf{d}} - \underline{\beta}), \quad (166)$$

$$\frac{1}{2} \underline{\mathbf{d}}^\top \underline{\mathbf{K}} \underline{\mathbf{d}} - \underline{\mathbf{d}}^\top \underline{\mathbf{F}}$$

$$\underline{\mathcal{L}}^\top \underline{\mathbf{d}} - \underline{\beta} = \underline{\mathbf{0}}$$

$$\underline{\mathbf{R}} = - \underline{\mathcal{L}} \underline{\ell}^*.$$

$$d_k = \sum_{i \neq k} \left( -\frac{\alpha_{ji}}{\alpha_{jk}} \right) d_i + \left( \frac{\beta_j}{\alpha_{jk}} \right), \quad j = 1 \dots m \quad (167)$$

$$\begin{bmatrix} \underline{\mathbf{r}} \\ \underline{\mathbf{t}} \end{bmatrix} = \underbrace{\begin{bmatrix} \underline{\mathbf{E}}_R \\ \underline{\mathbf{E}}_T \end{bmatrix}}_{\underline{\mathbf{E}}} \underline{\mathbf{d}} \quad \underline{\mathbf{d}} = \underbrace{\begin{bmatrix} \underline{\mathbf{E}}_R^\top & \underline{\mathbf{E}}_T^\top \end{bmatrix}}_{\underline{\mathbf{E}}^\top \equiv \underline{\mathbf{E}}^{-1}} \begin{bmatrix} \underline{\mathbf{r}} \\ \underline{\mathbf{t}} \end{bmatrix},$$

$$\underline{\mathbf{r}} = \underline{\mathbf{E}}_R \underline{\mathbf{d}} \quad \underline{\mathbf{t}} = \underline{\mathbf{E}}_T \underline{\mathbf{d}},$$

$$t_j = \sum_{h=1}^{n-m} \lambda_{jh} r_h + \delta_j, \quad j = 1 \dots m \quad (168)$$

$$\underline{\mathbf{t}} = \underline{\lambda} \underline{\mathbf{r}} + \underline{\delta}, \quad (169)$$

$$\begin{aligned} \underline{\mathbf{d}} &= \left( \underline{\mathbf{E}}^\top \begin{bmatrix} \underline{\mathbf{I}} \\ \underline{\lambda} \end{bmatrix} \right) \underline{\mathbf{r}} + \left( \underline{\mathbf{E}}^\top \begin{bmatrix} \underline{\mathbf{0}} \\ \underline{\delta} \end{bmatrix} \right) \\ &= \underline{\Delta} \underline{\mathbf{r}} + \underline{\Delta}; \end{aligned} \quad (170)$$

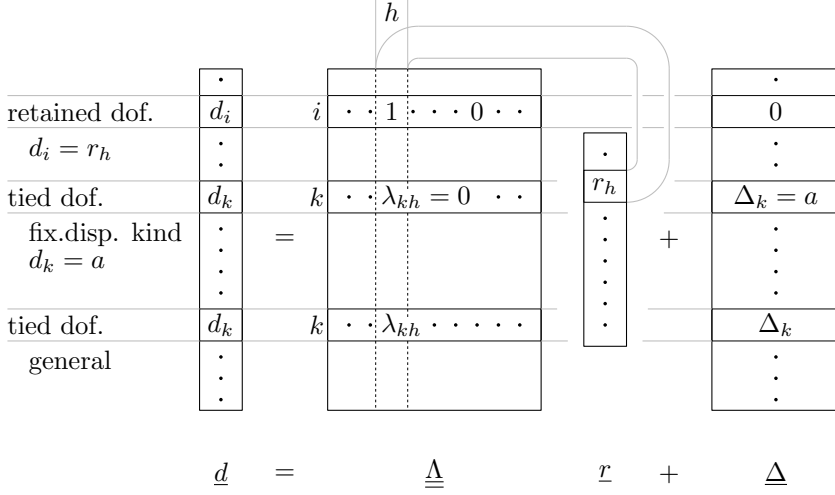

$$\delta \underline{d} = \underline{\Lambda} \delta \underline{r} = \underline{\Lambda}_1 \delta r_1 + \underline{\Lambda}_2 \delta r_2 + \dots + \underline{\Lambda}_{n-m} \delta r_{n-m} \quad (171)$$

$$\langle \underline{\Lambda}_h, \underline{R} \rangle = 0 \quad h = 1 \dots n - m, \quad (172)$$

or, equivalently,

$$\underline{\Lambda}^\top \underline{R} = \underline{0}. \quad (173)$$

$$\underline{K} (\underline{\Lambda} \underline{r} + \underline{\Delta}) = \underline{F} + \underline{R} \quad (174)$$

$$\underline{K} \underline{\Lambda} \underline{r} = (\underline{F} - \underline{K} \underline{\Delta}) + \underline{R}, \quad (175)$$

$$\underbrace{\underline{\Lambda}^\top \underline{K} \underline{\Lambda}}_{\underline{K}_R} \underline{r} = \underbrace{\underline{\Lambda}^\top (\underline{F} - \underline{K} \underline{\Delta})}_{\underline{F}_R} + \underbrace{\underline{\Lambda}^\top \underline{R}}_{=0}, \quad (176)$$

$$\underline{K}_R \underline{r} = \underline{F}_R \quad (177)$$

$$\underline{d}^* = \underline{\Lambda} \underline{r}^* + \underline{\Delta}; \quad (178)$$

$$\underline{R}^* = \underline{K} (\underline{\Lambda} \underline{r}^* + \underline{\Delta}) - \underline{F}. \quad (179)$$

$$\underline{d}_{ej}^* = \underline{P}_{ej} \underline{d}^*. \quad (180)$$

$$\underline{e} = \underline{B}_{ej}^e(\xi, \eta) \underline{d}_{ej}^* \quad \underline{\kappa} = \underline{B}_{ej}^\kappa(\xi, \eta) \underline{d}_{ej}^* \quad (181)$$

$$\underline{\epsilon} = (\underline{B}_{ej}^e(\xi, \eta) + \underline{B}_{ej}^\kappa(\xi, \eta)z) \underline{d}_{ej}^*. \quad (182)$$

$$\underline{\gamma}_z = \underline{B}_{ej}^\gamma(\xi, \eta) \underline{d}_{ej}^*. \quad (183)$$

$$\begin{bmatrix} u_i \\ v_i \\ w_i \\ \theta_i \\ \phi_i \\ \psi_i \end{bmatrix} = \underbrace{\begin{bmatrix} 1 & 0 & 0 & 0 & +(z_i - z_C) & -(y_i - y_C) \\ 0 & 1 & 0 & -(z_i - z_C) & 0 & +(x_i - x_C) \\ 0 & 0 & 1 & +(y_i - y_C) & -(x_i - x_C) & 0 \\ 0 & 0 & 0 & 1 & 0 & 0 \\ 0 & 0 & 0 & 0 & 1 & 0 \\ 0 & 0 & 0 & 0 & 0 & 1 \end{bmatrix}}_{\underline{\underline{L}}_i} \cdot \begin{bmatrix} u_C \\ v_C \\ w_C \\ \theta_C \\ \phi_C \\ \psi_C \end{bmatrix} \quad (184)$$

$$\begin{bmatrix} U_i \\ V_i \\ W_i \end{bmatrix} = q_i \left( \begin{bmatrix} a \\ b \\ c \end{bmatrix} + \begin{bmatrix} 0 & d & -f \\ -d & 0 & e \\ f & -e & 0 \end{bmatrix} \begin{bmatrix} x_i \\ y_i \\ z_i \end{bmatrix} \right), \quad (185)$$

$$\begin{bmatrix} U_C \\ V_C \\ W_C \end{bmatrix} = \sum_i \begin{bmatrix} U_i \\ V_i \\ W_i \end{bmatrix}, \quad \begin{bmatrix} \Theta_C \\ \Phi_C \\ \Psi_C \end{bmatrix} = \sum_i \begin{bmatrix} U_i \\ V_i \\ W_i \end{bmatrix} \wedge \begin{bmatrix} x_i - x_C \\ y_i - y_C \\ z_i - z_C \end{bmatrix} \quad (186)$$

$$\ddot{\underline{d}} = \underbrace{[\cdots \quad \underline{t}_l \quad \cdots]}_{\underline{T}} \underbrace{\begin{bmatrix} \vdots \\ \alpha_l \\ \vdots \end{bmatrix}}_{\underline{\alpha}}, \quad (187)$$

$$\underline{T}^\top \underline{M} \underline{T} \underline{\alpha} = \underline{T}^\top \underline{F} \quad (188)$$

$$\underline{M} \underline{T} \underline{\alpha} = \underline{F} [+R_l]$$

$$\underline{K} \underline{d} = \underline{F} - \underline{M} \underline{T} \underline{\alpha}, \quad (189)$$

$$\underline{\underline{\mathbf{M}}} \ddot{\underline{\mathbf{d}}} + \underline{\underline{\mathbf{C}}} \dot{\underline{\mathbf{d}}} + \underline{\underline{\mathbf{K}}} \underline{\mathbf{d}} = \underline{\mathbf{f}}(t), \quad \underline{\mathbf{d}} = \underline{\mathbf{d}}(t) \quad (190)$$

$$\underline{\mathbf{f}}(t) = \frac{\bar{\underline{\mathbf{f}}} e^{j\omega t} + \underline{\bar{\mathbf{f}}}^* e^{-j\omega t}}{2} = \text{Re}(\bar{\underline{\mathbf{f}}} e^{j\omega t}) \quad (191)$$

$$\underline{\mathbf{f}}(t) = \bar{\underline{\mathbf{f}}} e^{j\omega t} \quad (192)$$

$$\text{Re}(\bar{\underline{\mathbf{f}}} e^{j\omega t}) = \text{Re}(\bar{\underline{\mathbf{f}}}) \cos \omega t - \text{Im}(\bar{\underline{\mathbf{f}}}) \sin \omega t \quad (193)$$

$$\underline{\mathbf{d}}(t) = \bar{\underline{\mathbf{d}}} e^{j\omega t} \quad (194)$$

$$(-\omega^2 \underline{\underline{\mathbf{M}}} + j\omega \underline{\underline{\mathbf{C}}} + \underline{\underline{\mathbf{K}}}) \bar{\underline{\mathbf{d}}} = \bar{\underline{\mathbf{f}}} \quad (195)$$

$$(-\omega^2 \underline{\underline{\mathbf{M}}} + \underline{\underline{\mathbf{K}}}) \bar{\underline{\mathbf{d}}} = \underline{\mathbf{0}} \quad (196)$$

$$(\underline{\underline{\mathbf{M}}}^{-1} \underline{\underline{\mathbf{K}}} - \omega^2 \underline{\underline{\mathbf{I}}}) \hat{\underline{\mathbf{d}}} = \underline{\mathbf{0}}; \quad (197)$$

$$m_i = \hat{\underline{\mathbf{d}}}_i^\top \underline{\underline{\mathbf{M}}} \hat{\underline{\mathbf{d}}}_i = 1 \quad (198)$$

$$\underline{\mathbf{x}}(t) = a \hat{\underline{\mathbf{d}}}_i \sin(\omega_i t) \quad (199)$$

$$f(t) = \hat{\underline{\mathbf{f}}} \cos(\omega_i t), \quad (200)$$

$$\underbrace{(-\omega_i^2 \underline{\underline{\mathbf{M}}} + \underline{\underline{\mathbf{K}}}) \hat{\underline{\mathbf{d}}}_i}_{=0} a_i \sin(\omega_i t) + \omega_i a_i \underline{\underline{\mathbf{C}}} \hat{\underline{\mathbf{d}}}_i \cos(\omega_i t) = \bar{\underline{\mathbf{f}}} \cos(\omega_i t). \quad (201)$$

$$a_i = \frac{\hat{\underline{\mathbf{d}}}_i^\top \bar{\underline{\mathbf{f}}}}{\omega_i \hat{\underline{\mathbf{d}}}_i^\top \underline{\underline{\mathbf{C}}} \hat{\underline{\mathbf{d}}}_i} \quad (202)$$

$$\hat{\underline{\mathbf{d}}}_j^\top \underline{\underline{\mathbf{M}}} \hat{\underline{\mathbf{d}}}_i = m_i \delta_{ij} \quad \hat{\underline{\mathbf{d}}}_j^\top \underline{\underline{\mathbf{K}}} \hat{\underline{\mathbf{d}}}_i = m_i \omega_i^2 \delta_{ij} \quad (203)$$

$$\underline{\underline{\Xi}} = [\hat{\underline{\mathbf{d}}}_1 \quad \cdots \quad \hat{\underline{\mathbf{d}}}_l \quad \cdots \quad \hat{\underline{\mathbf{d}}}_m], \quad (204)$$

$$\bar{\underline{\mathbf{d}}} = \underline{\underline{\Xi}} \bar{\underline{\xi}} \quad (205)$$

$$\underline{\underline{\Xi}}^\top \underline{\underline{\mathbf{M}}} \underline{\underline{\Xi}} = \underline{\underline{\mathbf{I}}} \quad \underline{\underline{\Xi}}^\top \underline{\underline{\mathbf{K}}} \underline{\underline{\Xi}} = \underline{\underline{\Omega}} = \text{diag}(\omega_l^2); \quad (206)$$

$$\underline{\underline{\mathbf{C}}} = \alpha \underline{\underline{\mathbf{M}}} + \beta \underline{\underline{\mathbf{K}}} \quad (207)$$

$$\underline{\underline{\Xi}}^\top (-\omega^2 \underline{\underline{\mathbf{M}}} + j\omega \underline{\underline{\mathbf{C}}} + \underline{\underline{\mathbf{K}}}) \underline{\underline{\Xi}} \bar{\underline{\xi}} = \underline{\underline{\Xi}}^\top \bar{\underline{\mathbf{f}}} \quad (208)$$

$$(-\omega^2 \underline{\underline{\mathbf{I}}} + j\omega (\alpha \underline{\underline{\mathbf{I}}} + \beta \underline{\underline{\Omega}}) + \underline{\underline{\Omega}}) \bar{\underline{\xi}} = \underline{\underline{\Xi}}^\top \bar{\underline{\mathbf{f}}}, \quad (209)$$

$$(-\omega^2 + j\omega(\alpha + \beta\omega_l^2) + \omega_l^2) \xi_l = q_l, \quad j = 1 \dots m \quad (210)$$

$$\begin{aligned} \xi_l(t) &= \operatorname{Re}(\bar{\xi}_l) \cos \omega t - \operatorname{Im}(\bar{\xi}_l) \sin \omega t \\ &= |\bar{\xi}_l| \cos(\omega t + \psi_l - \phi_l) \end{aligned}$$

$$a_l = 1 - r_l^2 \qquad b_l = 2\zeta_l r_l \qquad r_l = \frac{\omega}{\omega_l}$$

$$|\bar{\xi}_l| = \frac{|\bar{q}_l|}{\omega_l^2} \frac{1}{\sqrt{a_l^2 + b_l^2}}$$

$$\psi_l = \arg(\bar{q}_l)$$

$$\phi_l = \arg(a_l + jb_l)$$

$$\operatorname{Re}(\bar{\xi}_l) = \frac{1}{\omega_l^2} \frac{a_l \operatorname{Re}(\bar{q}_l) + b_l \operatorname{Im}(\bar{q}_l)}{a_l^2 + b_l^2}$$

$$\operatorname{Im}(\bar{\xi}_l) = \frac{1}{\omega_l^2} \frac{a_l \operatorname{Im}(\bar{q}_l) - b_l \operatorname{Re}(\bar{q}_l)}{a_l^2 + b_l^2}.$$



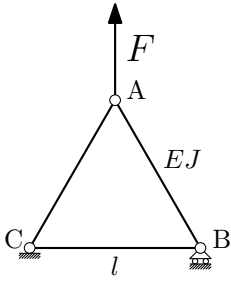

$$N_{AB} = N_{CA} = +\frac{F}{\sqrt{3}}$$

$$N_{BC} = -\frac{F}{2\sqrt{3}}$$

$$N_{\text{crit},i} = -\frac{\pi^2 i^2 EJ}{l^2}$$

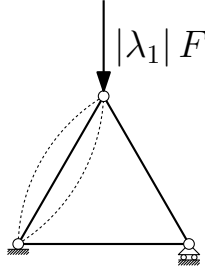

$$\lambda_1 = -\frac{\pi^2 EJ \sqrt{3}}{l^2 F}$$

moltepl. 2

minimum  $\lambda_i$  in absolute value

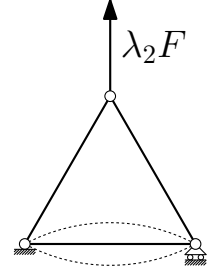

$$\lambda_2 = +\frac{\pi^2 EJ 2\sqrt{3}}{l^2 F}$$

minimum  $\lambda_i > 0$

$$\begin{aligned} \delta U_i &= \iiint_V \delta \underline{\epsilon}^\top (\underline{\sigma}_0 + \underline{\mathbf{D}} \underline{\epsilon}) dV \\ &= \iiint_V [\underline{\mathbf{B}}(\underline{\mathbf{d}}) \delta \underline{\mathbf{d}}]^\top (\underline{\sigma}_0 + \underline{\mathbf{D}} \underline{\mathbf{B}}(\underline{\mathbf{d}}) \underline{\mathbf{d}}) dV \\ &= \dots \\ &= \delta \underline{\mathbf{d}} ((\underline{\mathbf{K}}_{\text{ej}}^{\text{M}} + \underline{\mathbf{K}}_{\text{ej}}^{\text{G}}) \underline{\mathbf{d}} + o(\underline{\mathbf{d}})). \end{aligned}$$

$$(\underline{\mathbf{K}}^{\text{M}} + \lambda \underline{\mathbf{K}}^{\text{G}}) \delta \underline{\mathbf{d}} = \delta \underline{\mathbf{F}} \quad (211)$$

$$(\underline{\mathbf{K}}^{\text{M}} + \lambda_i \underline{\mathbf{K}}^{\text{G}}) \delta \hat{\underline{\mathbf{d}}}_i = 0 \quad (212)$$

# Bibliography

- [1] A. E. H. Love, *A treatise on the mathematical theory of elasticity*. Cambridge university press, 2013.
- [2] S. Timoshenko, S. Timoshenko, and J. Goodier, *Theory of Elasticity, by S. Timoshenko and JN Goodier,...* McGraw-Hill book Company, 1951.
- [3] S. Vlachoutsis, “Shear correction factors for plates and shells,” *International Journal for Numerical Methods in Engineering*, vol. 33, no. 7, pp. 1537–1552, 1992.
- [4] T. Chow, “On the propagation of flexural waves in an orthotropic laminated plate and its response to an impulsive load,” *Journal of Composite Materials*, vol. 5, no. 3, pp. 306–319, 1971.
- [5] V. Birman and C. W. Bert, “On the choice of shear correction factor in sandwich structures,” *Journal of Sandwich Structures & Materials*, vol. 4, no. 1, pp. 83–95, 2002.
- [6] C. Hua, “An inverse transformation for quadrilateral isoparametric elements: analysis and application,” *Finite elements in analysis and design*, vol. 7, no. 2, pp. 159–166, 1990.
- [7] B. M. Irons and A. Razzaque, “Experience with the patch test for convergence of finite elements,” in *The mathematical foundations of the finite element method with applications to partial differential equations*, pp. 557–587, Elsevier, 1972.
- [8] C. Militello and C. A. Felippa, “The individual element test revisited,” in *The finite element method in the 1990’s*, pp. 554–564, Springer, 1991.

- [9] R. MacNeal, *Finite Elements*. CRC Press, 1993.
- [10] T. J. Hughes and T. Tezduyar, “Finite elements based upon mindlin plate theory with particular reference to the four-node bilinear isoparametric element,” *Journal of applied mechanics*, vol. 48, no. 3, pp. 587–596, 1981.
- [11] J. Oden, “Calculation of geometric stiffness matrices for complex structures.,” *AIAA Journal*, vol. 4, no. 8, pp. 1480–1482, 1966.